



OWNER'S MANUAL

Majesty

YP125E
YP180E

5XL-F819D-E3

Welcome to the Yamaha world of motorcycling!

As the owner of the YP125E/YP180E, you are benefiting from Yamaha's vast experience and newest technology regarding the design and manufacture of high-quality products, which have earned Yamaha a reputation for dependability. Please take the time to read this manual thoroughly, so as to enjoy all advantages of your YP125E/YP180E. The owner's manual does not only instruct you in how to operate, inspect and maintain your scooter, but also in how to safeguard yourself and others from trouble and injury.



In addition, the many tips given in this manual will help keep your scooter in the best possible condition. If you have any further questions, do not hesitate to contact your Yamaha dealer.

The Yamaha team wishes you many safe and pleasant rides. So, remember to put safety first!

IMPORTANT MANUAL INFORMATION

EAU34110

Particularly important information is distinguished in this manual by the following notations:

	The Safety Alert Symbol means ATTENTION! BECOME ALERT! YOUR SAFETY IS INVOLVED!
	Failure to follow WARNING instructions could result in severe injury or death to the scooter operator, a bystander, or a person inspecting or repairing the scooter.
	A CAUTION indicates special precautions that must be taken to avoid damage to the scooter.
NOTE:	A NOTE provides key information to make procedures easier or clearer.

NOTE:

- This manual should be considered a permanent part of this scooter and should remain with it even if the scooter is subsequently sold.
- Yamaha continually seeks advancements in product design and quality. Therefore, while this manual contains the most current product information available at the time of printing, there may be minor discrepancies between your scooter and this manual. If you have any questions concerning this manual, please consult your Yamaha dealer.

EWA12410

WARNING

PLEASE READ THIS MANUAL CAREFULLY AND COMPLETELY BEFORE OPERATING THIS SCOOTER.

IMPORTANT MANUAL INFORMATION

EAUS1171

**YP125/YP180
OWNER'S MANUAL**
©2005 by YAMAHA MOTOR ESPAÑA S.A.
1st edition, September 2005
All rights reserved.
Any reprinting or unauthorized use
without the written permission of
YAMAHA MOTOR ESPAÑA S.A.
is expressly prohibited.
Printed in Spain.

TABLE OF CONTENTS

SAFETY INFORMATION	1-1	OPERATION AND IMPORTANT RIDING POINTS	5-1	Checking and lubricating the cables	6-16
DESCRIPTION	2-1	Starting a cold engine	5-1	Checking and lubricating the centerstand and sidestand	6-17
Left view	2-1	Starting off	5-2	Checking the front fork	6-17
Right view	2-2	Acceleration and deceleration	5-2	Checking the steering	6-17
Controls and Instruments	2-3	Braking	5-2	Checking the wheel bearings	6-18
INSTRUMENT AND CONTROL		Parking	5-3	Battery	6-18
FUNCTION	3-1	PERIODIC MAINTENANCE AND MINOR REPAIRS	6-1	Replacing the fuse	6-20
Main switch	3-1	Owner's tool kit	6-1	Replacing the headlight bulb or a front turn signal light bulb	6-20
Indicator lights	3-1	Periodic maintenance and lubrication chart	6-2	Replacing a front turn signal light bulb	6-21
Speedometer unit	3-3	Removing and installing cowlings and panels	6-5	Replacing the license plate light bulb	6-21
Battery voltage/fuel gauge	3-3	Checking the spark plug	6-6	Replacing the tail/brake light bulb or a rear turn signal light bulb	6-22
Clock	3-4	Engine oil	6-7	Troubleshooting	6-23
Handlebar switches	3-4	Final gear oil	6-9	Troubleshooting chart	6-24
Front brake lever	3-5	Coolant	6-10		
Rear brake lever	3-6	Air filter and V-belt case air filter elements	6-11	SCOOTER CARE AND STORAGE	7-1
Fuel tank cap	3-6	Adjusting the carburetor	6-12	Care	7-1
Fuel	3-6	Checking the throttle cable free play	6-12	Storage	7-3
Seat	3-7	Tires	6-13		
Front storage compartment	3-7	Adjusting the brake lever free play	6-15	SPECIFICATIONS	8-1
Storage compartment	3-7	Checking the front and rear brake pads	6-15	CONSUMER INFORMATION	9-1
Adjusting the rear shock absorber assemblies	3-8	Checking the brake fluid level	6-15	Identification numbers	9-1
Sidestand	3-8	Changing the brake fluid	6-16		
Sidestand switch operation check	3-9				
PRE-OPERATION CHECKS	4-1				
Pre-operation check list	4-2				

EAU10260

SCOOTERS ARE SINGLE TRACK VEHICLES. THEIR SAFE USE AND OPERATION ARE DEPENDENT UPON THE USE OF PROPER RIDING TECHNIQUES AS WELL AS THE EXPERTISE OF THE OPERATOR. EVERY OPERATOR SHOULD KNOW THE FOLLOWING REQUIREMENTS BEFORE RIDING THIS SCOOTER.

HE OR SHE SHOULD:

- OBTAIN THOROUGH INSTRUCTIONS FROM A COMPETENT SOURCE ON ALL ASPECTS OF SCOOTER OPERATION.
- OBSERVE THE WARNINGS AND MAINTENANCE REQUIREMENTS IN THE OWNER'S MANUAL.
- OBTAIN QUALIFIED TRAINING IN SAFE AND PROPER RIDING TECHNIQUES.
- OBTAIN PROFESSIONAL TECHNICAL SERVICE AS INDICATED BY THE OWNER'S MANUAL AND/OR WHEN MADE NECESSARY BY MECHANICAL CONDITIONS.

Safe riding

- Always make pre-operation checks. Careful checks may help prevent an accident.
- This scooter is designed to carry the operator and passenger.
- The failure of motorists to detect and recognize scooters in traffic is the predominating cause of automobile/scooter accidents. Many accidents have been caused by an automobile driver who did not see the scooter. Making yourself conspicuous appears to be very effective in reducing the chance of this type of accident.

Therefore:

- Wear a brightly colored jacket.
- Use extra caution when approaching and passing through intersections, since intersections are the most likely places for scooter accidents to occur.
- Ride where other motorists can see you. Avoid riding in another motorist's blind spot.

- Many accidents involve inexperienced operators. In fact, many operators who have been involved in accidents do not even have a current driver's license.
 - Make sure that you are qualified and that you only lend your scooter to other qualified operators.
 - Know your skills and limits. Staying within your limits may help you to avoid an accident.
 - We recommend that you practice riding your scooter where there is no traffic until you have become thoroughly familiar with the scooter and all of its controls.
- Many accidents have been caused by error of the scooter operator. A typical error made by the operator is veering wide on a turn due to EXCESSIVE SPEED or undercornering (insufficient lean angle for the speed).

SAFETY INFORMATION

1

- Always obey the speed limit and never travel faster than warranted by road and traffic conditions.
- Always signal before turning or changing lanes. Make sure that other motorists can see you.
- The posture of the operator and passenger is important for proper control.
- The operator should keep both hands on the handlebar and both feet on the footboard during operation to maintain control of the scooter.
- The passenger should always hold onto the operator, the seat strap or grab bar, if equipped, with both hands and keep both feet on the passenger footrests.
- Never carry a passenger unless he or she can firmly place both feet on the passenger footrests.
- Never ride under the influence of alcohol or other drugs.
- This scooter is designed for on-road use only. It is not suitable for off-road use.

Protective apparel

The majority of fatalities from scooter accidents are the result of head injuries. The use of a safety helmet is the single most critical factor in the prevention or reduction of head injuries.

- Always wear an approved helmet.
- Wear a face shield or goggles. Wind in your unprotected eyes could contribute to an impairment of vision which could delay seeing a hazard.
- The use of a jacket, substantial shoes, trousers, gloves, etc., is effective in preventing or reducing abrasions or lacerations.
- Never wear loose-fitting clothes, otherwise they could catch on the control levers or wheels and cause injury or an accident.
- Never touch the engine or exhaust system during or after operation. They become very hot and can cause burns. Always wear protective clothing that

covers your legs, ankles, and feet.

- Passengers should also observe the above precautions.

Modifications

Modifications made to this scooter not approved by Yamaha, or the removal of original equipment, may render the scooter unsafe for use and may cause severe personal injury. Modifications may also make your scooter illegal to use.

Loading and accessories

Adding accessories or cargo to your scooter can adversely affect stability and handling if the weight distribution of the scooter is changed. To avoid the possibility of an accident, use extreme caution when adding cargo or accessories to your scooter. Use extra care when riding a scooter that has added cargo or accessories. Here are some general guidelines to follow if loading cargo or adding accessories to your scooter:

Loading

The total weight of the operator, passenger, accessories and cargo must not exceed the maximum load limit of 183kg, (403,5lb). When loading within this weight limit, keep the following in mind:

- Cargo and accessory weight should be kept as low and close to the scooter as possible. Make sure to distribute the weight as evenly as possible on both sides of the scooter to minimize imbalance or instability.
- Shifting weights can create a sudden imbalance. Make sure that accessories and cargo are securely attached to the scooter before riding. Check accessory mounts and cargo restraints frequently.
- Never attach any large or heavy items to the handlebar, front fork, or front fender. Such items can create unstable handling or a slow steering response.

Accessories

Genuine Yamaha accessories have been specifically designed for use on this scooter. Since Yamaha cannot test all other accessories that may be available, you must personally be responsible for the proper selection, installation and use of non-Yamaha accessories. Use extreme caution when selecting and installing any accessories.

Keep the following guidelines in mind, as well as those provided under “Loading” when mounting accessories.

- Never install accessories or carry cargo that would impair the performance of your scooter. Carefully inspect the accessory before using it to make sure that it does not in any way reduce ground clearance or cornering clearance, limit suspension travel, steering travel or control operation, or obscure lights or reflectors.

- Accessories fitted to the handlebar or the front fork area can create instability due to improper weight distribution or aerodynamic changes. If accessories are added to the handlebar or front fork area, they must be as lightweight as possible and should be kept to a minimum.
- Bulky or large accessories may seriously affect the stability of the scooter due to aerodynamic effects. Wind may attempt to lift the scooter, or the scooter may become unstable in cross winds. These accessories may also cause instability when passing or being passed by large vehicles.
- Certain accessories can displace the operator from his or her normal riding position. This improper position limits the freedom of movement of the operator and may limit control ability, therefore, such accessories are not recommended.

SAFETY INFORMATION

EAU10360

- Use caution when adding electrical accessories. If electrical accessories exceed the capacity of the scooter's electrical system an electric failure could result, which could cause a dangerous loss of lights or engine power.

Gasoline and exhaust gas

- **GASOLINE IS HIGHLY FLAMMABLE:**
 - Always turn the engine off when refueling.
 - Take care not to spill any gasoline on the engine or exhaust system when refueling.
 - Never refuel while smoking or in the vicinity of an open flame.
- Never start the engine or let it run for any length of time in a closed area. The exhaust fumes are poisonous and may cause loss of consciousness and death within a short time. Always operate your scooter in an area that has adequate ventilation.

- Always turn the engine off before leaving the scooter unattended and remove the key from the main switch. When parking the scooter, note the following:
 - The engine and exhaust system may be hot, therefore, park the scooter in a place where pedestrians or children are not likely to touch these hot areas.
 - Do not park the scooter on a slope or soft ground, otherwise it may fall over.
 - Do not park the scooter near a flammable source (e.g., a kerosene heater, or near an open flame), otherwise it could catch fire.
- If you should swallow any gasoline, inhale a lot of gasoline vapor, or allow gasoline to get into your eyes, see your doctor immediately. If any gasoline spills on your skin or clothing, immediately wash the affected area with soap and water and change your clothes.

Further safe-riding points

- Be sure to signal clearly when making turns.
- Braking can be extremely difficult on a wet road. Avoid hard braking, because the scooter could slide. Apply the brakes slowly when stopping on a wet surface.
- Slow down as you approach a corner or turn. Once you have completed a turn, accelerate slowly.
- Be careful when passing parked cars. A driver might not see you and open a door in your path.
- Railroad crossings, streetcar rails, iron plates on road construction sites, and manhole covers become extremely slippery when wet. Slow down and cross them with caution. Keep the scooter upright, otherwise it could slide out from under you.
- The brake lining could get wet when you wash the scooter. After washing the scooter, check the brakes before riding.

- Always wear a helmet, gloves, trousers (tapered around the cuff and ankle so they do not flap), and a bright colored jacket.
- Do not carry too much luggage on the scooter. An overloaded scooter is unstable. Use a strong cord to secure any luggage to the carriers. A loose load will affect the stability of the scooter and could divert your attention from the road.

DESCRIPTION

EAU10410

Left view

2

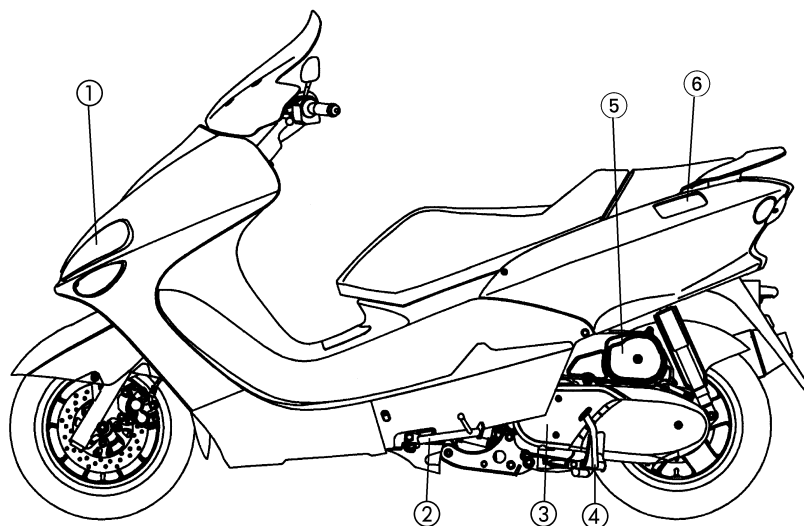

- 1. Headlight (page 6-20)
- 2. Sidestand (page 3-8)
- 3. V-Belt case air filter (page 6-11)

- 4. Centerstand (page 6-17)
- 5. Air filter (page 6-11)
- 6. Fuel tank cap (page 3-6)

Right view

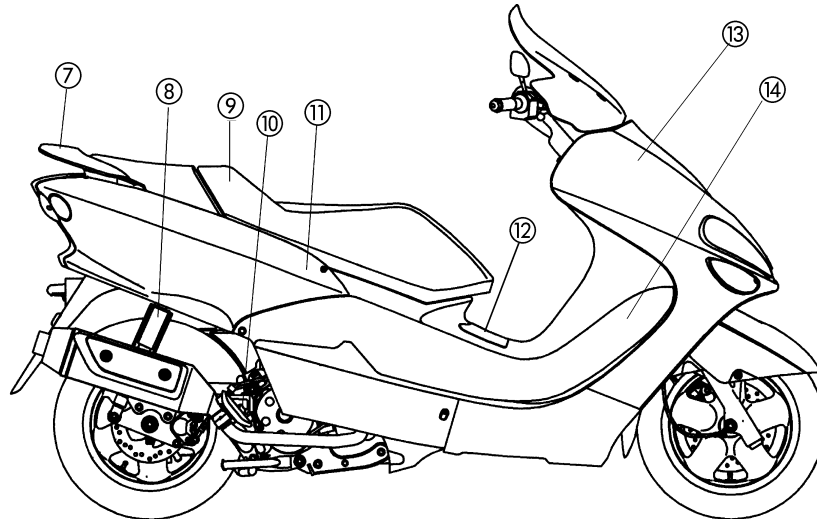

- 7. Passenger handle
- 8. Rear shock absorber (page 3-8)
- 9. Seat (page 3-7)
- 10. Engine oil dipstick (page 6-7)

- 11. Storage compartment (page 3-7)
- 12. Battery/fuse box (page 6-18)
- 13. Coolant reservoir (page 6-10)
- 14. Radiator

DESCRIPTION

EAU10430

Controls and instruments

2

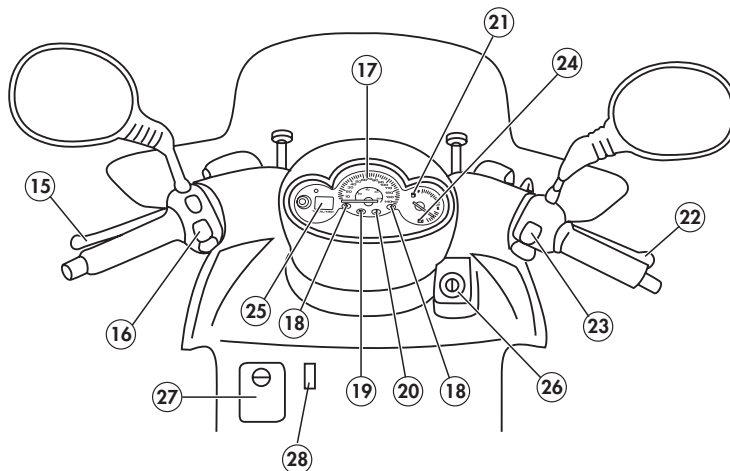

- 15. Rear brake lever (page 3-6)
- 16. Left handlebar switch (page 3-4)
- 17. Speedometer (page 3-3)
- 18. Turn indicator lights (page 3-1)
- 19. High beam indicator light (page 3-1)
- 20. Coolant temperature warning light (page 3-1)
- 21. Fuel gauge (page 3-3)

- 22. Front brake lever (page 3-5)
- 23. Right handlebar switch (page 3-4)
- 24. Battery voltage (page 3-3)
- 25. Odometer/Clock (page 3-4)
- 26. Main switch/Steering lock (page 3-1)
- 27. Front compartment (page 3-7)
- 28. Coolant level gauge window (page 6-10)

INSTRUMENT AND CONTROL FUNCTIONS

Main switch

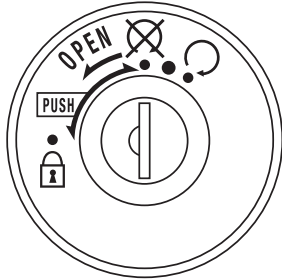

EAU10450

The main switch controls the ignition and lighting systems. The various main switch positions are described below.

ON

All electrical systems are supplied with power, and the engine can be started. The key cannot be removed.

EAU10630

OFF

All electrical systems are off. The key can be removed.

EAU10660

“⊙”

The coolant temperature warning light should come on when the key is turned to “⊙”. (See page 3-2.)

EAU1020

LOCK

The steering is locked, and all electrical systems are off. The key can be removed.

EAU10700

To lock the steering

1. Turn the handlebars all the way to the left.
2. Push the key in from the “OFF” position, release it, and then turn it to “LOCK”.
3. Remove the key.

To unlock the steering

Insert the key and turn it to “OFF”.

⚠ WARNING

Never turn the key to “OFF” or “LOCK” while the vehicle is moving, otherwise the electrical systems will be switched off, which may result in loss of control or an accident. Make sure that the vehicle is stopped before turning the key to “OFF” or “LOCK”.

3

EAU10980

Indicator lights

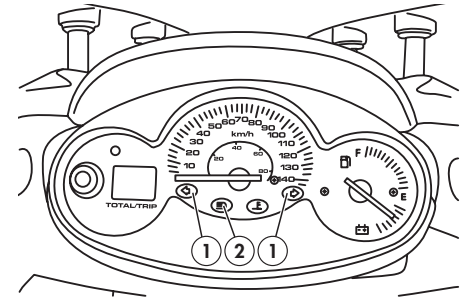

1. Turn signal indicator lights
2. High beam indicator light

INSTRUMENT AND CONTROL FUNCTIONS

EAU11030

Turn signal indicator lights “↔” and “↷”

The corresponding indicator light flashes when the turn signal switch is pushed to the left or right.

EAU11080

High beam indicator light “≡”

This indicator light comes on when the high beam of the headlight is switched on.

EAU11390

Oil change indicator light “🛢️”

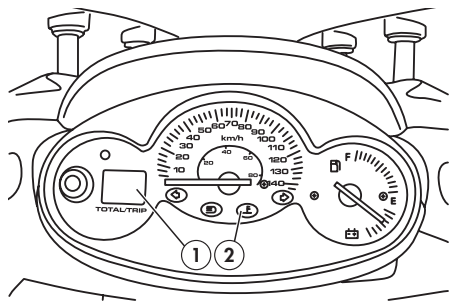

1. Oil change indicator
2. Coolant temperature warning light

This indicator light comes on at the initial 1000 km (600 mi) and every 3000 km (1800 mi) thereafter to indi-

cate that the engine oil should be changed.

If the engine oil is changed before the oil change indicator comes on (i.e. before the periodic oil change interval has been reached), the indicator light must be reset after the oil change for the next periodic oil change to be indicated at the correct time. (See page 6-8.)

The electrical circuit of the indicator light can be checked according to the following procedure.

1. Set the engine stop switch to “⊙” and turn the key to “ON”.
2. Check that the indicator comes on for a few seconds and then goes off.
3. If the indicator light does not come on, have a Yamaha dealer check the electrical circuit.

NOTE:

The oil change indicator light may flash when the engine is revved with the scooter on the centerstand, but this does not indicate a malfunction.

EAUM1080

Coolant temperature warning light “🌡️”

This warning light comes on when the engine overheats. When this occurs, stop the engine immediately and allow the engine to cool.

The electrical circuit of the warning light can be checked according to the following procedure.

1. Turn the key to “⊙”.
2. If the warning light does not come on, have a Yamaha dealer check the electrical circuit.

ECA10020

CAUTION

Do not operate the engine if it is overheated.

INSTRUMENT AND CONTROL FUNCTIONS

Speedometer unit

EAU11660

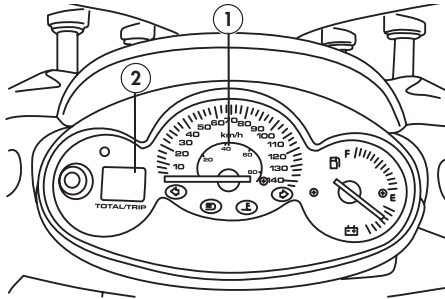

1. Speedometer unit
2. Odometer

The speedometer unit is equipped with a speedometer, an odometer and a tripmeter. The speedometer shows riding speed. The odometer shows the total distance traveled. The tripmeter shows the distance traveled since it was last set to zero. Pushing the “TRIP” button switches the display between the odometer mode “ODO” and the tripmeter mode “TRIP”. To reset the tripmeter, enter the “TRIP” mode, and then hold down the “TRIP” button for at least one second. The tripmeter can be used together with the fuel gauge to esti-

mate the distance that can be traveled with a full tank of fuel. This information will enable you to plan future fuel stops.

Setting the odometer/tripmeter reading mode

The odometer and tripmeter can be set to count in either miles or kilometers according to the following procedure.

1. Turn the key to “ON” while pressing the reset button.
2. Release the reset button when the display comes on.
3. The current mode appears in the display: “CONT” (continental) for the kilometer mode and “EnGL” (English) for the mile mode.
4. Press the reset button to switch the mode.
5. Press the reset button for two seconds to confirm the setting.

NOTE:

- The odometer/tripmeter reading mode can be changed any number of times while the odometer reading is below 10, but it cannot be changed anymore after the reading has reached 10.
- Switching between the mile and the kilometer mode does not change or convert the current odometer/tripmeter reading.

3

EAUM1100

Battery voltage/fuel gauge

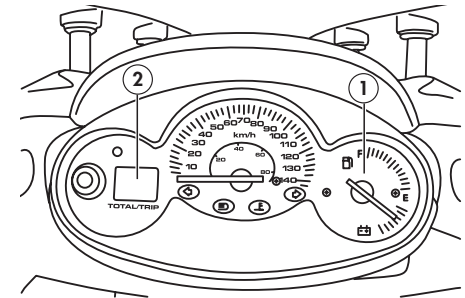

1. Fuel gauge
2. Clock

INSTRUMENT AND CONTROL FUNCTIONS

When the key is turned to “OFF”, the voltage/fuel gauge indicates the battery voltage.

NOTE:

If the battery voltage drops to 10 V, have a Yamaha dealer check the battery.

3

When the key is turned to “ON”, the voltage/fuel gauge indicates the amount of fuel in the fuel tank after indicating the battery voltage for two seconds. The needle moves towards “E” (empty) as the fuel level decreases. When the needle reaches “E”, refuel as soon as possible.

NOTE:

Do not allow the fuel tank to empty itself completely.

EAU12330

Anti-theft alarm (optional)

This motorcycle can be equipped with an optional anti-theft alarm by a Yamaha dealer. Contact a Yamaha dealer for more information.

EAUS1210

Clock

To set the clock

1. Turn the key to “ON”.
2. Press the “TRIP” button for two seconds, and the hour display will flash.
3. Press the “TRIP” button to set the hours.
4. Press the “TRIP” button for two seconds, and the first minute digit will flash.
5. Press the “TRIP” button to set the first minute digit.
6. Press the “TRIP” button for two more seconds, and the second minute digit will flash.
7. Press the “TRIP” button to set the second minute digit.
8. Press the “TRIP” button for two seconds to set the clock.

EAU12343

Handlebar switches

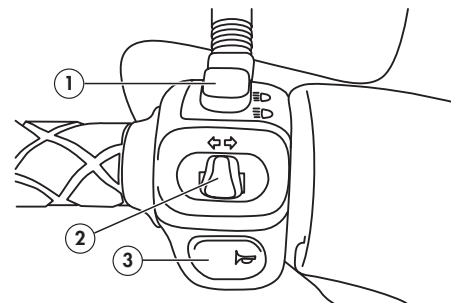

1. Dimmer switch “ E/D , D/D ”
2. Turn signal switch “ L/R ”
3. Horn switch “ H ”

EAUS1020

Dimmer switch “ E/D / D/D ”

Set this switch to “ E/D ” for the high beam and to “ D/D ” for the low beam. With the headlight on low beam, press this switch downwards to flash the headlight.

INSTRUMENT AND CONTROL FUNCTIONS

EAU12460

Turn signal switch “↔/↷”

To signal a right-hand turn, push this switch to “↷”. To signal a left-hand turn, push this switch to “↔”. When released, the switch returns to the center position. To cancel the turn signal lights, push the switch in after it has returned to the center position.

EAU12500

Horn switch “📢”

Press this switch to sound the horn.

EAU12690

Start switch “🔌”

Push this switch to crank the engine with the starter.

ECA10050

CAUTION

See page 5-1 for starting instructions prior to starting the engine.

EAU12763

Hazard switch “⚠”

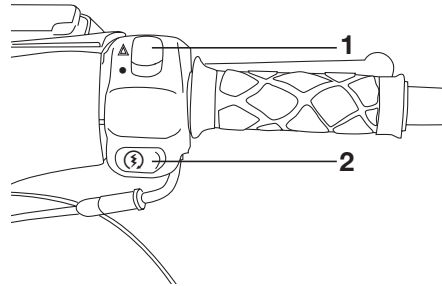

1. Hazard switch “⚠”
2. Start switch “🔌”

With the key in the “ON” position, turn this switch to “⚠” to turn on the hazard lights (simultaneous flashing of all turn signal lights).

The hazard lights are used in case of an emergency or to warn other drivers when your vehicle is stopped where it might be a traffic hazard.

ECA10060

CAUTION

Do not use the hazard light for an extended length of time, otherwise the battery may discharge.

EAU12900

Front brake lever

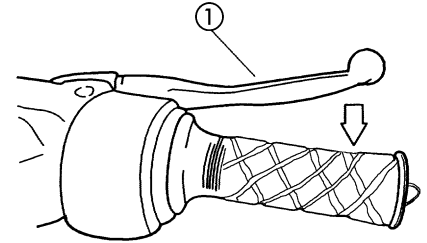

1. Front brake lever

The front brake lever is located on the right handlebar grip. To apply the front brake, pull this lever toward the handlebar grip.

INSTRUMENT AND CONTROL FUNCTIONS

EAU12950

Rear brake lever

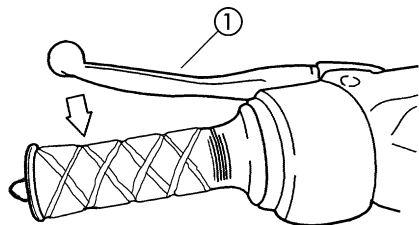

1. Rear brake lever

The rear brake lever is located on the left handlebar grip. To apply the rear brake, pull this lever toward the handlebar grip.

EAUS1040

Fuel tank cap

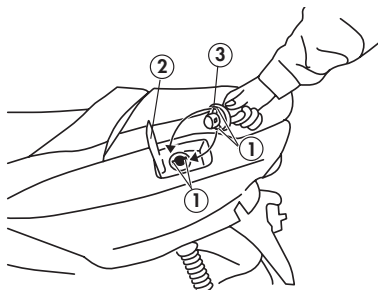

1. Aligning marks
2. Fuel tank cover
3. Fuel tank cap

To open the fuel tank cap

1. Open the fuel tank cap cover by pushing in on the rear end of it.
2. Insert the key in the lock and turn it clockwise.

To close the fuel tank cap

1. Align the match marks, and then push the fuel tank cap into the original position.
2. Turn the key counterclockwise and remove it.
3. Close the fuel tank cover.

EAU13220

Fuel

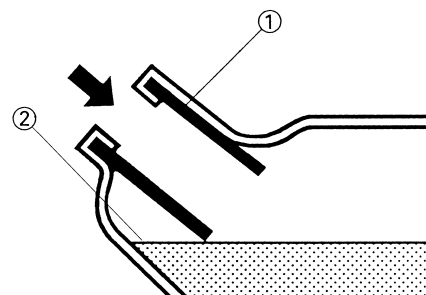

1. Filling tube
2. Fuel level

Make sure that there is sufficient fuel in the tank. When refueling, be sure to insert the pump nozzle into the fuel tank filler hole and to fill the tank to the bottom of the filler tube as shown.

EWA10880

⚠ WARNING

- Do not overfill the fuel tank, otherwise it may overflow when the fuel warms up and expands.
- Avoid spilling fuel on the hot engine.

INSTRUMENT AND CONTROL FUNCTIONS

CAUTION

ECA10070

Immediately wipe off spilled fuel with a clean, dry, soft cloth, since fuel may deteriorate painted surfaces or plastic parts.

Seat

EAU13890



To open the seat

1. Insert the key in the lock, and then turn it as shown.
2. Fold the seat up.

To close the seat

1. Fold the seat down, and then push it down to lock it in place.
2. Remove the key.

NOTE:

Make sure that the seat is properly secured before riding.

Front storage compartment

EAU14400

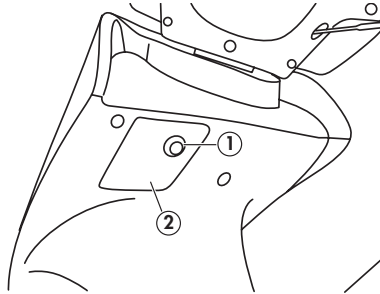

1. Lock
2. Glove compartment

WARNING

EWA11190

- Do not exceed the load limit of 10 kg (22,05 lb) for the front storage compartment.
- Do not exceed the maximum load of 324 kg (714,42 lb) for the vehicle.

Storage compartment

EAU14540

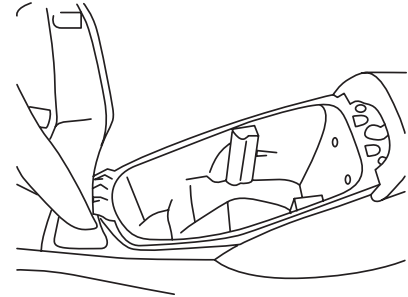

To open the storage compartment
Insert the key into the lock, turn it clockwise, and then pull on it to open the storage compartment lid.

To close the storage compartment
Push the storage compartment lid into the original position, and then remove the key.

INSTRUMENT AND CONTROL FUNCTIONS

⚠ WARNING

EWA10960

- Do not exceed the load limit of 10 kg (22,05 lb) for the storage compartment.
- Do not exceed the maximum load of 324 kg (714,42 lb) for the vehicle.

CAUTION

ECA10100

Never attempt to turn an adjusting mechanism beyond the maximum or minimum settings.

⚠ WARNING

EWA10210

Always adjust both shock absorber assemblies equally, otherwise poor handling and loss of stability may result.

Adjust the spring preload as follows. To increase the spring preload and thereby harden the suspension, turn the adjusting ring on each shock absorber assembly in direction (a). To decrease the spring preload and thereby soften the suspension, turn the adjusting ring on each shock absorber assembly in direction (b).

NOTE:

Align the appropriate notch in the adjusting ring with the position indicator on the shock absorber.

Spring preload setting:

Minimum (soft):

1

Standard:

2

Maximum (hard):

3,4

EAU15300

Sidestand

The sidestand is located on the left side of the frame. Raise the sidestand or lower it with your foot while holding the motorcycle upright.

NOTE:

The built-in sidestand switch is part of the ignition circuit cut-off system, which cuts the ignition in certain situations. (See further down for an explanation of the ignition circuit cut-off system.)

EAU10240

⚠ WARNING

The vehicle must not be ridden with the sidestand down, or if the sidestand cannot be properly moved up (or does not stay up), otherwise the sidestand could contact the ground

Adjusting the shock absorber assemblies

EAU14880

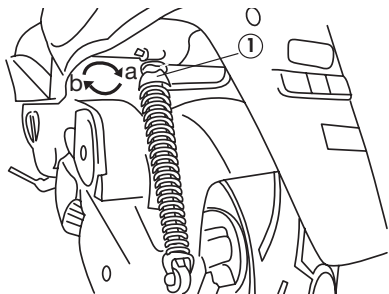

1. Shock-absorber pre-tensioned strut

Each shock absorber assembly is equipped with a spring preload adjusting ring.

INSTRUMENT AND CONTROL FUNCTIONS

EWA10260

and distract the operator, resulting in a possible loss of control. Yamaha's ignition circuit cut-off system has been designed to assist the operator in fulfilling the responsibility of raising the sidestand before starting off. Therefore, check this system regularly as described below and have a Yamaha dealer repair it if it does not function properly.

⚠ WARNING

- The vehicle must be placed on the centerstand during this inspection.
- If a malfunction is noted, have a Yamaha dealer check the system before riding.

EAUT1091

Sidestand switch operation check

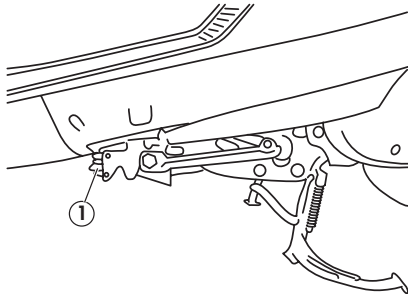

1. Sidestand switch

Check the operation of the sidestand switch against the information below.

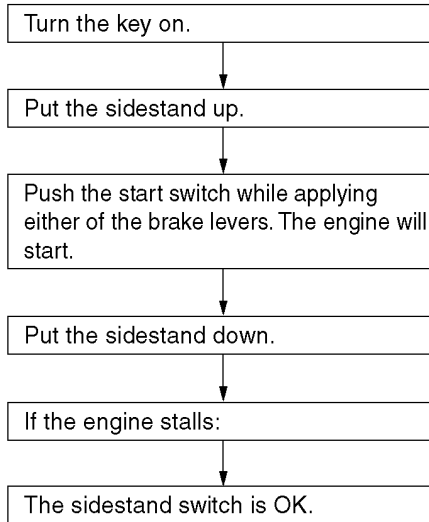

PRE-OPERATION CHECKS

EAU15591

The condition of a vehicle is the owner's responsibility. Vital components can start to deteriorate quickly and unexpectedly, even if the vehicle remains unused (for example, as a result of exposure to the elements). Any damage, fluid leakage or loss of tire air pressure could have serious consequences. Therefore, it is very important, in addition to a thorough visual inspection, to check the following points before each ride.

4

NOTE: _____

Pre-operation checks should be made each time the vehicle is used. Such an inspection can be accomplished in a very short time; and the added safety it assures is more than worth the time involved.

EWA11150

⚠ WARNING _____

If any item in the Pre-operation check list is not working properly, have it inspected and repaired before operating the vehicle.

PRE-OPERATION CHECKS

EAU15603

Pre-operation check list

ITEM	CHECKS	PAGE
Fuel	<ul style="list-style-type: none">• Check fuel level in fuel tank.• Refuel if necessary.• Check fuel line for leakage.	3-3, 3-6
Engine oil	<ul style="list-style-type: none">• Check oil level in engine.• If necessary, add recommended oil to specified level.• Check vehicle for oil leakage.	6-7
Final transmission oil	<ul style="list-style-type: none">• Check vehicle for oil leakage.	6-9
Coolant	<ul style="list-style-type: none">• Check coolant level in reservoir.• If necessary, add recommended coolant to specified level.• Check cooling system for leakage.	6-10
Front brake	<ul style="list-style-type: none">• Check operation.• If soft or spongy, have Yamaha dealer bleed hydraulic system.• Check brake pads for wear.• Replace if necessary.• Check fluid level in reservoir.• If necessary, add recommended brake fluid to specified level.• Check hydraulic system for leakage.	3-5, 6-15
Rear brake	<ul style="list-style-type: none">• Check operation.• If soft or spongy, have Yamaha dealer bleed hydraulic system.• Check brake pads for wear.• Replace if necessary.• Check fluid level in reservoir.• If necessary, add recommended brake fluid to specified level.• Check hydraulic system for leakage.	3-6, 6-15
Throttle grip	<ul style="list-style-type: none">• Make sure that operation is smooth.• Check cable free play.• If necessary, have Yamaha dealer adjust cable free play and lubricate cable and grip housing.	5-2, 6-12

PRE-OPERATION CHECKS

ITEM	CHECKS	PAGE
Wheels and tires	<ul style="list-style-type: none">• Check for damage.• Check tire condition and tread depth.• Check air pressure.• Correct if necessary.	6-13
Brake levers	<ul style="list-style-type: none">• Make sure that operation is smooth.• Lubricate lever pivoting points if necessary.	3-5, 3-6, 6-15
Centerstand, sidestand	<ul style="list-style-type: none">• Make sure that operation is smooth.• Lubricate pivots if necessary.	3-8, 3-9, 6-17
Chassis fasteners	<ul style="list-style-type: none">• Make sure that all nuts, bolts and screws are properly tightened.• Tighten if necessary.	—
Battery	<ul style="list-style-type: none">• Check fluid level.• Fill with distilled water if necessary.	6-18

OPERATION AND IMPORTANT RIDING POINTS

EAU15980
EWA10870

⚠ WARNING

- Become thoroughly familiar with all operating controls and their functions before riding. Consult a Yamaha dealer regarding any control or function that you do not thoroughly understand.
- Never start the engine or operate it in a closed area for any length of time. Exhaust fumes are poisonous, and inhaling them can cause loss of consciousness and death within a short time. Always make sure that there is adequate ventilation.
- For safety, always start the engine with the centerstand down.

Starting a cold engine

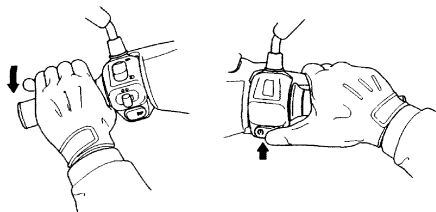

ZAJM004

EAUM1210

CAUTION

See page 5-3 for engine break-in instructions prior to operating the vehicle for the first time.

ECA10250

1. Turn the key to “O”.
2. Close the throttle completely.
3. Start the engine by pushing the start switch while applying the front or rear brake.

NOTE:

If the engine fails to start, release the start switch, wait a few seconds, and then try again. Each starting attempt should be as short as possible to preserve the battery. Do not crank the engine more than 10 seconds on any one attempt.

ECA11040

CAUTION

For maximum engine life, never accelerate hard when the engine is cold!

OPERATION AND IMPORTANT RIDING POINTS

EAU16760

Starting off

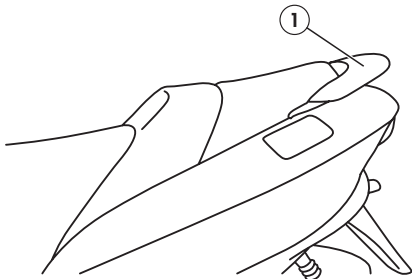

1. Passenger handle

NOTE:

Before starting off, allow the engine to warm up.

1. While pulling the rear brake lever with your left hand and holding the grab bar with your right hand, push the scooter off the centerstand.
2. Sit astride the seat, and then adjust the rear view mirrors.
3. Switch the turn signal on.
4. Check for oncoming traffic, and then slowly turn the throttle grip (on the right) in order to take off.
5. Switch the turn signal off.

Acceleration and deceleration

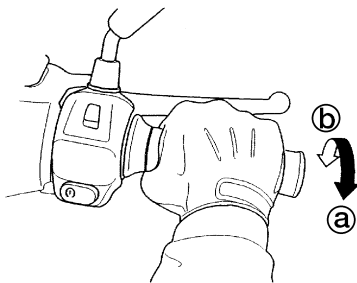

The speed can be adjusted by opening and closing the throttle. To increase the speed, turn the throttle grip in direction (a). To reduce the speed, turn the throttle grip in direction (b).

EAU16780

Braking



1. Close the throttle completely.
2. Apply both front and rear brakes simultaneously while gradually increasing the pressure.

EWA10300

WARNING

- **Avoid braking hard or suddenly (especially when leaning over to one side), otherwise the scooter may skid or overturn.**
- **Railroad crossings, streetcar rails, iron plates on road construction sites, and manhole covers become extremely slippery when wet. Therefore, slow down when approaching such areas and cross them with caution.**

OPERATION AND IMPORTANT RIDING POINTS

- **Keep in mind that braking on a wet road is much more difficult.**
- **Ride slowly down a hill, as braking downhill can be very difficult.**

EAU16830

Engine break-in

There is never a more important period in the life of your engine than the period between 0 and 1000 km (600 mi). For this reason, you should read the following material carefully.

Since the engine is brand new, do not put an excessive load on it for the first 1000 km (600 mi). The various parts in the engine wear and polish themselves to the correct operating clearances. During this period, prolonged full-throttle operation or any condition that might result in engine overheating must be avoided.

EAU17150

0~150 km (0~90 mi)

Avoid prolonged operation above 1/3 throttle.

After every hour of operation, stop the engine, and then let it cool for five to ten minutes.

Vary the engine speed from time to time. Do not operate the engine at one set throttle position.

150~500 km (90~300 mi)

Avoid prolonged operation above 1/2 throttle.

Rev the engine freely through the gears, but do not use full throttle at any time.

500~1000 km (300~600 mi)

Avoid prolonged operation above 3/4 throttle.

ECA10370

CAUTION

After 1000 km (600 mi) of operation, the transmission oil must be changed.

1000 km (600 mi) and beyond

Avoid prolonged full-throttle operation. Vary the engine speed occasionally.

ECA10270

CAUTION

If any engine trouble should occur during the engine break-in period, immediately have a Yamaha dealer check the vehicle.

EAU17200

Parking

When parking, stop the engine, and then remove the key from the main switch.

EWA10310

⚠ WARNING

- **Since the engine and exhaust system can become very hot, park in a place where pedestrians or children are not likely to touch them.**
- **Do not park on a slope or on soft ground, otherwise the vehicle may overturn.**

PERIODIC MAINTENANCE AND MINOR REPAIR

EAU17280

Safety is an obligation of the owner. Periodic inspection, adjustment and lubrication will keep your vehicle in the safest and most efficient condition possible. The most important points of inspection, adjustment, and lubrication are explained on the following pages.

The intervals given in the periodic maintenance and lubrication chart should be simply considered as a general guide under normal riding conditions. However, DEPENDING ON THE WEATHER, TERRAIN, GEOGRAPHICAL LOCATION, AND INDIVIDUAL USE, THE MAINTENANCE INTERVALS MAY NEED TO BE SHORTENED.

EWA10320

⚠ WARNING

If you are not familiar with maintenance work, have a Yamaha dealer do it for you.

EWA10330

⚠ WARNING

This scooter is designed for use on paved roads only. If this scooter is operated in abnormally dusty, muddy or wet conditions, the air filter element should be cleaned or replaced more frequently, otherwise rapid engine wear may result. Consult a Yamaha dealer for proper maintenance intervals.

EAU17320

Owner's tool kit

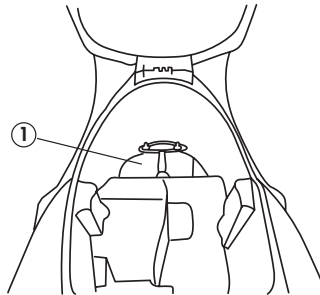

1. Owner's tool kit

The service information included in this manual and the tools provided in the owner's tool kit are intended to

assist you in the performance of preventive maintenance and minor repairs. However, additional tools such as a torque wrench may be necessary to perform certain maintenance work correctly.

NOTE:

If you do not have the tools or experience required for a particular job, have a Yamaha dealer perform it for you.

EWA10350

⚠ WARNING

Modifications not approved by Yamaha may cause loss of performance and render the vehicle unsafe for use. Consult a Yamaha dealer before attempting any changes.

PERIODIC MAINTENANCE AND MINOR REPAIR

EAU17705

Periodic maintenance and lubrication chart

NOTE:

- The annual checks must be performed every year, except if a kilometer-based maintenance is performed instead.
- From 50000 km, repeat the maintenance intervals starting from 10000 km.
- Items marked with an asterisk should be performed by a Yamaha dealer as they require special tools, data and technical skills.

No	ITEM	CHECK OR MAINTENANCE JOB	ODOMETER READING (x 1000 Km)					ANNUAL CHECK
			1	10	20	30	40	
1	* Fuel line	• Check fuel and vacuum hoses for cracks or damage.		√	√	√	√	√
2	* Fuel filter	• Check condition.			√		√	
3	Spark plug	• Check condition. • Clean and regap.		√		√		
		• Replace.			√		√	
4	* Valves	• Check valve clearance. • Adjust.			√		√	
5	Air filter element	• Clean.		√		√		
		• Replace.			√		√	
6	V-belt case air filter element	• Clean.		√	√	√	√	
7	* Battery	• Check electrolyte level and specific gravity. • Make sure that the breather hose is properly routed.		√	√	√	√	√
8	* Front brake	• Check operation, fluid level and vehicle for fluid leakage.	√	√	√	√	√	√
		• Replace brake pads.	Whenever worn to the limit					

PERIODIC MAINTENANCE AND MINOR REPAIR

No	ITEM	CHECK OR MAINTENANCE JOB	ODOMETER READING (x 1000 Km)					ANNUAL CHECK	
			1	10	20	30	40		
9	* Rear brake	<ul style="list-style-type: none"> • Check operation, fluid level and vehicle for fluid leakage. • Replace brake pads. 	√	√	√	√	√	√	
			Whenever worn to the limit						
10	* Wheels	<ul style="list-style-type: none"> • Check runout and for damage. 		√	√	√	√		
11	* Wheel bearings	<ul style="list-style-type: none"> • Check bearing for looseness or damage. 		√	√	√	√		
12	* Steering bearings	<ul style="list-style-type: none"> • Check bearing play and steering for roughness. • Lubricate with lithium-soap-based grease. 	√	√	√	√	√		
			Every 24000 km						
13	* Chassis fasteners	<ul style="list-style-type: none"> • Make sure that all nuts, bolts and screws are properly tightened. 		√	√	√	√	√	
14	Sidestand, centerstand	<ul style="list-style-type: none"> • Check operation. • Lubricate. 		√	√	√	√	√	
15	* Sidestand switch	<ul style="list-style-type: none"> • Check operation. 	√	√	√	√	√	√	
16	* Front fork	<ul style="list-style-type: none"> • Check operation and for oil leakage. 		√	√	√	√		
17	* Shock absorber assemblies	<ul style="list-style-type: none"> • Check operation and shock absorbers for oil leakage. 		√	√	√	√		
18	* Carburetor	<ul style="list-style-type: none"> • Adjust engine idling speed. 	√	√	√	√	√	√	
19	Engine oil	<ul style="list-style-type: none"> • Change. (See page *-*) • Check oil level and vehicle for oil leakage. 	√	When the oil change indicator light comes on (every 3000 km)					
			Every 3000 km					√	
20	* Engine oil strainer	<ul style="list-style-type: none"> • Clean. 	√						
21	* Cooling system	<ul style="list-style-type: none"> • Check coolant level and vehicle for coolant leakage. • Change. 		√	√	√	√	√	
			Every 3 years						
22	Final gear oil	<ul style="list-style-type: none"> • Check oil level and vehicle for oil leakage. • Change. 	√	√		√			
			√		√		√		
23	* V-belt	<ul style="list-style-type: none"> • Replace. 	Every 10000 km						

PERIODIC MAINTENANCE AND MINOR REPAIR

No	ITEM	CHECK OR MAINTENANCE JOB	ODOMETER READING (x 1000 Km)					ANNUAL CHECK
			1	10	20	30	40	
24	* Front and rear brake switches	<ul style="list-style-type: none"> • Check operation. 	√	√	√	√	√	√
25	Moving parts and cables	<ul style="list-style-type: none"> • Lubricate. 		√	√	√	√	√
26	* Muffler and exhaust pipe	<ul style="list-style-type: none"> • Check the screw clamp for looseness. 	√	√	√	√	√	
27	* Lights, signals and switches	<ul style="list-style-type: none"> • Check operation. • Adjust headlight beam. 	√	√	√	√	√	√

PERIODIC MAINTENANCE AND MINOR REPAIR

EAU18711

Removing and installing cowlings and panels

Cowling A

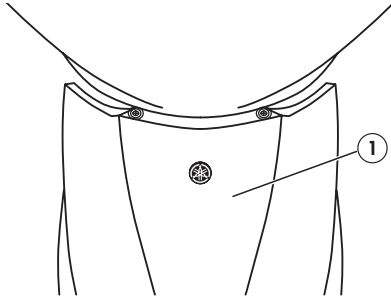

1. Cowling

The cowlings and panels shown need to be removed to perform some of the maintenance jobs described in this chapter. Refer to this section each time a cowling or panel needs to be removed and installed.

Cowling B

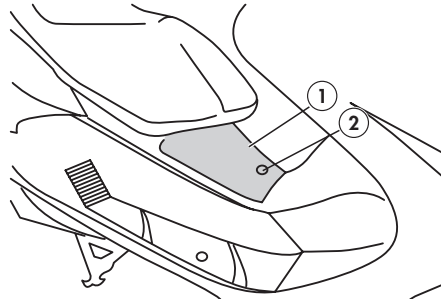

1. Panel
2. Screw (x1)

To remove the cowling

Remove the screws, and then take the cowling off.

To install the cowling

Place the cowling in the original position, and then install the screws.

EAU18790

Panels

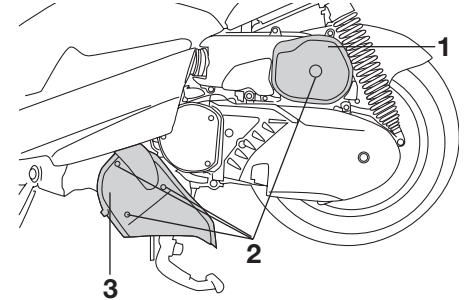

1. Panel
2. Screw (x4)

To remove the panel

Remove the screws, and then take the panel off.

To install the panel

Place the panel in the original position, and then install the screws.

EAU19210

PERIODIC MAINTENANCE AND MINOR REPAIR

Checking the spark plug

EAU19620

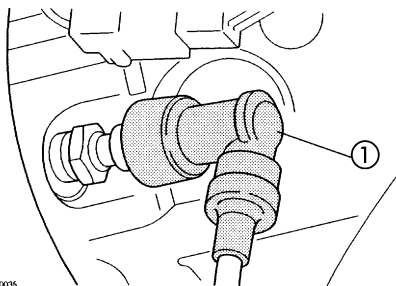

ZALM0035

1. Spark plug cap

The spark plug is an important engine component, which should be checked periodically, preferably by a Yamaha dealer. Since heat and deposits will cause any spark plug to slowly erode, it should be removed and checked in accordance with the periodic maintenance and lubrication chart. In addition, the condition of the spark plug can reveal the condition of the engine.

The porcelain insulator around the center electrode of the spark plug should be a medium-to-light tan (the ideal color when the vehicle is ridden

normally). If the spark plug shows a distinctly different color, the engine could be defective. Do not attempt to diagnose such problems yourself. Instead, have a Yamaha dealer check the vehicle.

If the spark plug shows signs of electrode erosion and excessive carbon or other deposits, it should be replaced.

Specified spark plug:
CR8E (NGK)

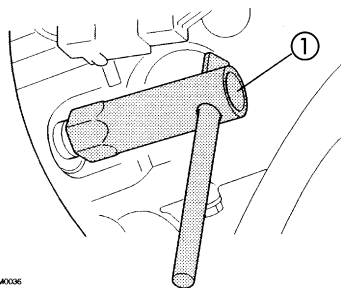

ZALM0036

1. Spark plug wrench

Before installing a spark plug, the spark plug gap should be measured with a wire thickness gauge and, if necessary, adjusted to specification.

Spark plug gap:
0,7~0,8 mm (0,0275in~0,0315in)

Clean the surface of the spark plug gasket and its mating surface, and then wipe off any grime from the spark plug threads.

Tightening torque:
Spark plug:
20 Nm 2,0 m•kgf, 14,46ft•lb)

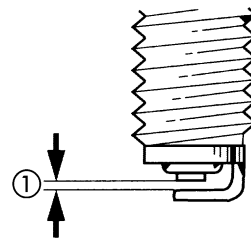

ZALM0037

1. Spark plug gap

NOTE:

If a torque wrench is not available when installing a spark plug, a good estimate of the correct torque is 1/4~1/2 turn past finger tight. However, the spark plug should be tightened to the specified torque as soon as possible.

PERIODIC MAINTENANCE AND MINOR REPAIR

EAUS1241

Engine oil

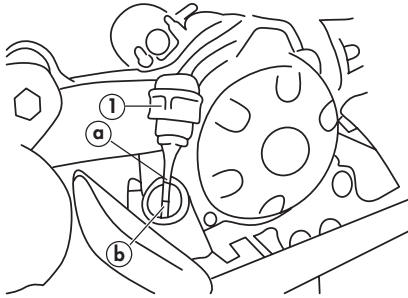

1. Dipstick

(a) Maximum level (b) Minimum level

The engine oil level should be checked before each ride. In addition, the oil must be changed at the intervals specified in the periodic maintenance and lubrication chart and when the oil change indicator light comes on.

To check the engine oil level

1. Place the vehicle on the centerstand.

NOTE:

Make sure that the vehicle is positioned straight up when checking the oil level. A slight tilt to the side can result in a false reading.

2. Start the engine, warm it up for several minutes, and then turn it off.
3. Wait a few minutes until the oil settles, remove the oil filler cap, wipe the dipstick clean, insert it back into the oil filler hole (without screwing it in), and then remove it again to check the oil level.

NOTE:

The engine oil should be between the minimum and maximum level marks.

4. If the engine oil is below the minimum level mark, add sufficient oil of the recommended type to raise it to the correct level.
5. Insert the dipstick into the oil filler hole, and then tighten the oil filler cap.

To change the engine oil

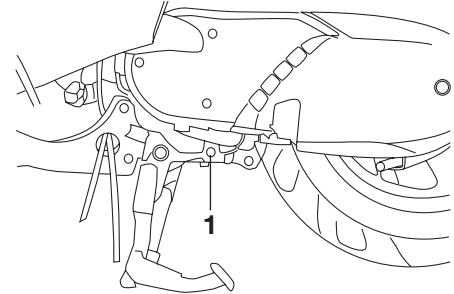

1. Drainage cap

1. Start the engine, warm it up for several minutes, and then turn it off.
2. Place an oil pan under the engine to collect the used oil.
3. Remove the engine oil filler cap and the engine oil drain bolt to drain the oil from the crankcase.

ECA10410

CAUTION

When removing the engine oil drain bolt, the O-ring, spring, and oil strainer will fall out. Take care not to lose these parts.

PERIODIC MAINTENANCE AND MINOR REPAIR

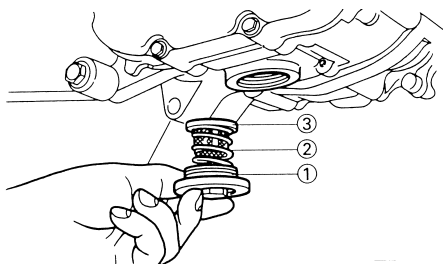

1. O-ring
2. Compression spring
3. Strainer

4. Clean the oil strainer with solvent, and then check it for damage and replace it if necessary.
5. Check the O-ring for damage and replace it if necessary.
6. Install the oil strainer, spring, O-ring and engine drain bolt, and then tighten the drain bolt to the specified torque.

Tightening torque:

Engine oil drain bolt:
32 Nm (3,2 m•kgf, 23,15ft•lb)

NOTE:

Make sure that the O-ring is properly seated.

7. Add the specified amount of the recommended engine oil, and then install and tighten the oil filler cap.

Recommended engine oil:

See page 8-1.

Oil change quantity:

1,3 L (0,286 US qt) (1,144 Imp.qt)

ECA11670

CAUTION

- Do not use oils with a diesel specification of “CD” or oils of a higher quality than specified. In addition, do not use oils labeled “ENERGY CONSERVING II” or higher.
- Be sure no foreign material enters the crankcase.

8. Start the engine, and then let it idle for several minutes while checking it for oil leakage. If oil is leaking, immediately turn the engine off and check for the cause.
9. Reset the oil change indicator light according to the following procedure.

To reset the oil change indicator light

1. Push and hold the “TRIP” button for a MAXIMUM of three seconds. While pushing the “TRIP” button, turn the key to “O”.
2. Release the “TRIP” button and the oil change indicator light will go off.
3. Turn the key to “ \otimes ”.

NOTE:

If the engine oil is changed before the oil change indicator light comes on (i.e. before the periodic oil change interval has been reached), the indicator light must be reset after the oil change for the next periodic oil change to be indicated at the correct time. To reset the oil change indicator light before the periodic oil change interval has been reached, follow the above procedure, but note that the indicator light will come on for 1.4 seconds after releasing the reset button, otherwise repeat the procedure.

PERIODIC MAINTENANCE AND MINOR REPAIR

EAU20011

EWA10370

Final gear oil

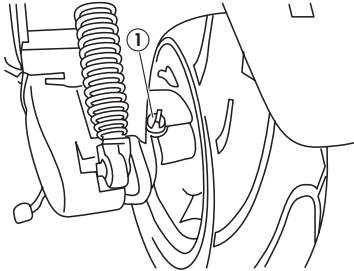

1. Oil filler cap

The final gear case must be checked for oil leakage before each ride. If any leakage is found, have a Yamaha dealer check and repair the vehicle. In addition, the final gear oil must be changed as follows at the intervals specified in the periodic maintenance and lubrication chart.

⚠ WARNING

- Make sure that no foreign material enters the final gear case.
- Make sure that no oil gets on the tire or wheel.

To check the final gear oil level

1. Place the vehicle on the centerstand.

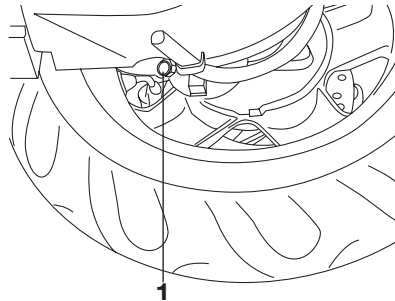

1. Drain bolt

NOTE:

- The final gear oil level must be checked on a cold engine.
- Make sure that the vehicle is positioned straight up when checking the oil level. A slight tilt to the side can result in a false reading.

2. Remove the oil filler bolt, and then check the oil level in the final gear case.

NOTE:

The oil level should be at the brim of the filler hole.

3. If the oil is below the brim of the filler hole, add sufficient oil of the recommended type to raise it to the correct level.
4. Install the oil filler bolt, and then tighten it to the specified torque.

Tightening torque:

Final gear oil filler bolt:
22 Nm (2,2 m•kgf, 15,91 ft•lbf)

To change the final gear oil

1. Place an oil pan under the final gear case to collect the used oil.
2. Remove the oil filler bolt and drain bolt to drain the oil from the final gear case.
3. Install the final gear oil drain bolt, and then tighten it to the specified torque.

PERIODIC MAINTENANCE AND MINOR REPAIR

Tightening torque:

Final gear oil drain bolt:
22 Nm (2,2 m•kgf, 15,91 ft•lbf)

4. Add the recommended final gear oil to the brim of the filler hole.

Recommended final gear oil:

Shaft drive gear oil (Part No.:
9079E-SH001-00)

Oil quantity:

0,15 L (0,033 US qt) (0,132 Imp.qt)

5. Install the oil filler bolt, and then tighten it to the specified torque.
6. Check the final gear case for oil leakage. If oil is leaking, check for the cause.

Coolant

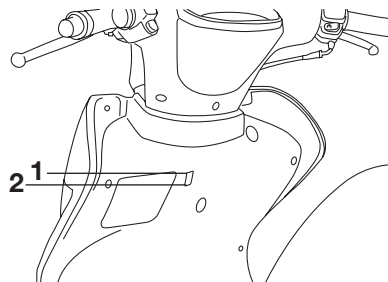

EAU20070

1. Maximum level
2. Minimum level

The coolant level should be checked before each ride. In addition, the coolant must be changed at the intervals specified in the periodic maintenance and lubrication chart.

EAUS1080

To check the coolant level

1. Place the vehicle on a level surface and hold it in an upright position.

NOTE:

- The coolant level must be checked on a cold engine since the level varies with engine temperature.
- Make sure that the vehicle is positioned straight up when checking the coolant level. A slight tilt to the side can result in a false reading.

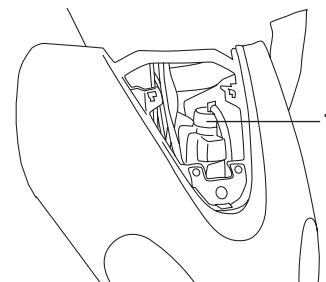

1. Coolant tank cap

2. Check the coolant level through the check window.

NOTE:

The coolant should be between the minimum and maximum level marks.

PERIODIC MAINTENANCE AND MINOR REPAIR

3. If the coolant is at or below the minimum level mark, remove the front cowling by removing the screws.
4. Open the reservoir cap, and then add coolant to the maximum level mark.

Coolant reservoir capacity:
0,45 L (0,099 US qt) (0,396 Imp.qt)

ECA10470

CAUTION

- If coolant is not available, use distilled water or soft tap water instead. Do not use hard water or salt water since it is harmful to the engine.
- If water has been used instead of coolant, replace it with coolant as soon as possible, otherwise the engine may not be sufficiently cooled and the cooling system will not be protected against frost and corrosion.

- If water has been added to the coolant, have a Yamaha dealer check the antifreeze content of the coolant as soon as possible, otherwise the effectiveness of the coolant will be reduced.

5. Close the reservoir cap, and then install the front cowling by installing the screws.

Air filter and V-belt case air filter elements

The air filter and the V-belt case air filter elements should be cleaned at the intervals specified in the periodic maintenance and lubrication chart. Clean both filter elements more frequently if you are riding in unusually wet or dusty areas.

EAUM1320

Cleaning the air filter element

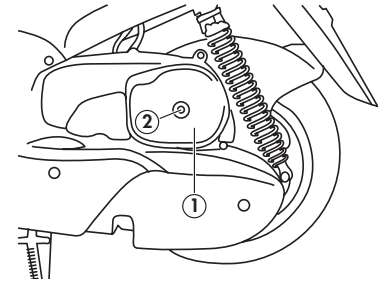

1. Air filter case cover
2. Screw (x 1)

1. Place the scooter on the centerstand.
2. Remove the air filter case cover by removing the screws.
3. Pull the air filter element out.

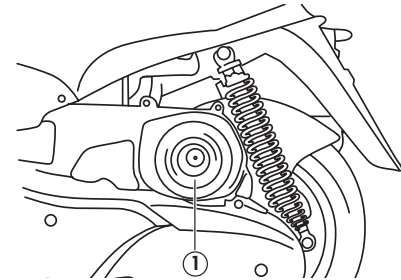

1. Air filter
4. Lightly tap the air filter element to remove most of the dust and dirt,

PERIODIC MAINTENANCE AND MINOR REPAIR

EAU21381

and then blow the remaining dirt out with compressed air.

5. Check the air filter element for damage and replace it if necessary.
6. Insert the air filter element into the air filter case.
7. Install the air filter case cover by installing the screws.

Cleaning the V-belt case air filter element

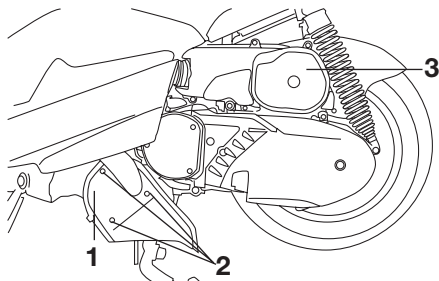

1. V-belt case air filter cover
2. Screw (x 3)
3. Air filter element

1. Remove the V-belt case air filter cover by removing the screws.
2. Remove the air filter element, and then blow out the dirt with compressed air as shown.

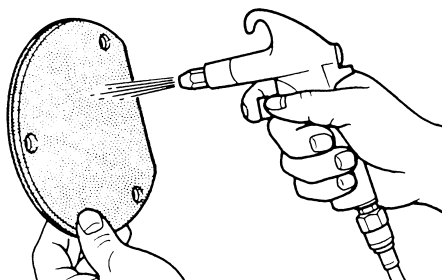

3. Check the air filter element for damage and replace it if necessary.
4. Install the air filter element with the colored side facing outward.
5. Install the V-belt case air filter cover by installing the screws.

ECA10530

CAUTION

- Make sure that each filter element is properly seated in its case.
- The engine should never be operated without the filter elements installed, otherwise the piston(s) and/or cylinder(s) may become excessively worn.

Adjusting the carburetor

The carburetor is an important part of the engine and requires very sophisticated adjustment. Therefore, all carburetor adjustments should be left to a Yamaha dealer, who has the necessary professional knowledge and experience.

EAU21381

Checking the throttle cable free play

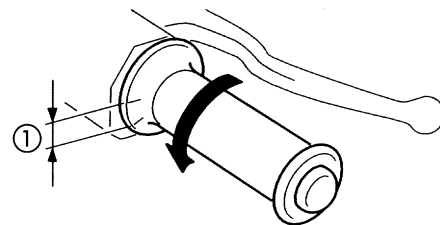

The throttle cable free play should measure 1,5~3,0 mm (0,060~0,118 in) at the throttle grip. Periodically check the throttle cable free play and, if necessary, have a Yamaha dealer adjust it.

PERIODIC MAINTENANCE AND MINOR REPAIR

EAU21540

Tires

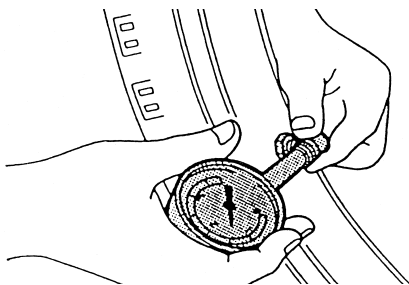

To maximize the performance, durability, and safe operation of your motorcycle, note the following points regarding the specified tires.

Tire air pressure

The tire air pressure should be checked and, if necessary, adjusted before each ride.

EWA10500

⚠ WARNING

- The tire air pressure must be checked and adjusted on cold tires (i.e., when the temperature of the tires equals the ambient temperature).
- The tire air pressure must be adjusted in accordance with the riding speed and with the

total weight of rider, passenger, cargo, and accessories approved for this model.

Tire air pressure (measured on cold tires):

Up to 90 kg (198 lb):

Front:

190 kPa (27,02 psi)
(1,9 kgf/cm²)

Rear:

220 kPa (31,29 psi)
(2,2 kgf/cm²)

90 kg (198 lb) to maximum load:

Front:

190 kPa (27,02 psi)
(1,9 kgf/cm²)

Rear:

240 kPa (34,14 psi)
(2,4 kgf/cm²)

Maximum load*:

183 kg (403,51 lb)

* Total weight of rider, passenger, cargo and accessories

EWA11020

⚠ WARNING

Because loading has an enormous impact on the handling, braking, performance and safety characteristics of your motorcycle, you should keep the following precautions in mind.

- **NEVER OVERLOAD THE MOTORCYCLE!** Operation of an overloaded motorcycle may result in tire damage, loss of control, or severe injury. Make sure that the total weight of rider, passenger, cargo, and accessories does not exceed the specified maximum load for the vehicle.
- Do not carry along loosely packed items, which can shift during a ride.
- Securely pack the heaviest items close to the center of the motorcycle and distribute the weight evenly on both sides.
- Adjust the suspension and tire air pressure with regard to the load.
- Check the tire condition and air pressure before each ride.

PERIODIC MAINTENANCE AND MINOR REPAIR

EWA10570

Tire inspection

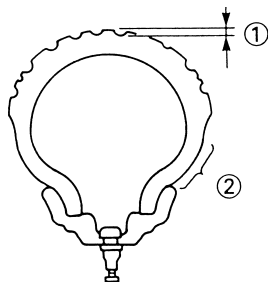

1. Depth
2. Side face

The tires must be checked before each ride. If the center tread depth reaches the specified limit, if the tire has a nail or glass fragments in it, or if the sidewall is cracked, have a Yamaha dealer replace the tire immediately.

Minimum tire tread depth (front and rear):

1.6 mm (0.06 in)

NOTE:

The tire tread depth limits may differ from country to country. Always comply with the local regulations.

Tire information

This motorcycle is equipped with tube tires.

EWA10460

WARNING

- The front and rear tires should be of the same make and design, otherwise the handling characteristics of the vehicle cannot be guaranteed.
- After extensive tests, only the tires listed below have been approved for this model by Yamaha Motor España, S.A.

Front tire:

Size:
120/70-12 51L
Manufacturer/model:
MICHELIN
CHENG SING
PIRELLI

Rear tire:

Size:
130/70-12 56L
Manufacturer/model:
MICHELIN
CHENG SING
PIRELLI

WARNING

- Have a Yamaha dealer replace excessively worn tires. Besides being illegal, operating the motorcycle with excessively worn tires decreases riding stability and can lead to loss of control.
- The replacement of all wheel- and brake-related parts, including the tires, should be left to a Yamaha dealer, who has the necessary professional knowledge and experience.
- It is not recommended to patch a punctured tube. If unavoidable, however, patch the tube very carefully and replace it as soon as possible with a high-quality product.

PERIODIC MAINTENANCE AND MINOR REPAIR

EAU22100

Adjusting the brake lever free play

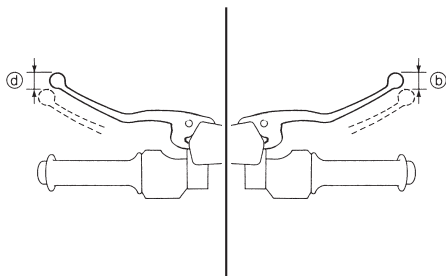

(b) Free play 2 ~ 5 mm

(d) Free play 2 ~ 5 mm

6

The brake lever free play should measure 2~5 mm (0,079~0,197 in) as shown. Periodically check the brake lever free play and, if necessary, have a Yamaha dealer adjust it.

EWA10640

⚠ WARNING

An incorrect brake lever free play indicates a hazardous condition in the brake system. Do not operate the motorcycle until the brake system has been checked or repaired by a Yamaha dealer.

EAU22340

Checking the front and rear brake pads

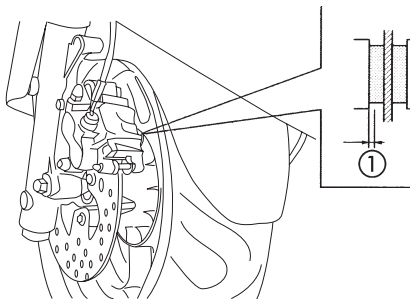

1. Wear limit

The front and rear brake pads must be checked for wear at the intervals specified in the periodic maintenance and lubrication chart. To check the brake pad wear, measure the lining thickness. If the lining thickness is less than 0,5 mm (0,02 in), have a Yamaha dealer replace the brake pads as a set.

EAU22580

Checking the brake fluid level

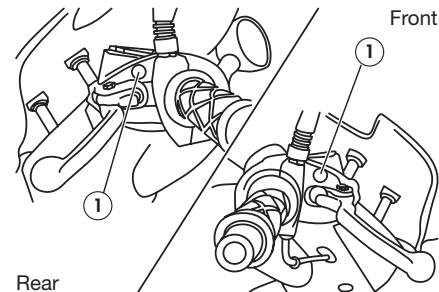

1. Minimum level

Insufficient brake fluid may allow air to enter the brake system, possibly causing it to become ineffective. Before riding, check that the brake fluid is above the minimum level mark and replenish if necessary. A low brake fluid level may indicate worn brake pads and/or brake system leakage. If the brake fluid level is low, be sure to check the brake pads for wear and the brake system for leakage.

PERIODIC MAINTENANCE AND MINOR REPAIR

Observe these precautions:

- When checking the fluid level, make sure that the top of the brake fluid reservoir is level.
- Use only the recommended quality brake fluid, otherwise the rubber seals may deteriorate, causing leakage and poor braking performance.

Recommended brake fluid:
DOT 4

- Refill with the same type of brake fluid. Mixing fluids may result in a harmful chemical reaction and lead to poor braking performance.
- Be careful that water does not enter the brake fluid reservoir when refilling. Water will significantly lower the boiling point of the fluid and may result in vapor lock.
- Brake fluid may deteriorate painted surfaces or plastic parts. Always clean up spilled fluid immediately.

- As the brake pads wear, it is normal for the brake fluid level to gradually go down. However, if the brake fluid level goes down suddenly, have a Yamaha dealer check the cause.

EAUM1360

Changing the brake fluid

Have a Yamaha dealer change the brake fluid at the intervals specified in the periodic maintenance and lubrication chart. In addition, have the brake hose replaced every four years or whenever it is damaged or leaking.

EAU23100

Checking and lubricating the cables

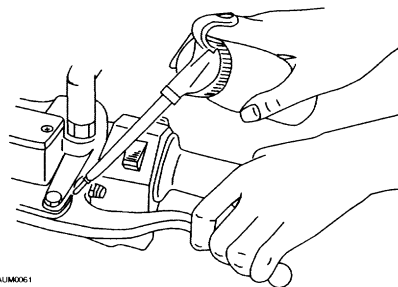

ZAUM0061

The operation of all control cables and the condition of the cables should be checked before each ride, and the cables and cable ends should be lubricated if necessary. If a cable is damaged or does not move smoothly, have a Yamaha dealer check or replace it.

Recommended lubricant:
Engine oil

EWA10720

⚠ WARNING

Damage to the outer sheath may interfere with proper cable operation and will cause the inner cable to rust. Replace a damaged cable as soon as possible to prevent unsafe conditions.

PERIODIC MAINTENANCE AND MINOR REPAIR

Checking and lubricating the centerstand and sidestand

EAU23210

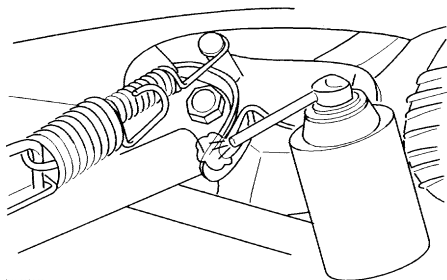

The operation of the centerstand and sidestand should be checked before each ride, and the pivots and metal-to-metal contact surfaces should be lubricated if necessary.

EWA10740

⚠ WARNING

If the centerstand or sidestand does not move up and down smoothly, have a Yamaha dealer check or repair it.

Recommended lubricant:

Lithium-soap-based grease (all-purpose grease)

Checking the front fork

EAU23271

The condition and operation of the front fork must be checked as follows at the intervals specified in the periodic maintenance and lubrication chart.

To check the condition

EWA10750

⚠ WARNING

Securely support the motorcycle so that there is no danger of it falling over.

Check the inner tubes for scratches, damage and excessive oil leakage.

To check the operation

1. Place the motorcycle on a level surface and hold it in an upright position.

2. While applying the front brake, push down hard on the handlebars several times to check if the front fork compresses and rebounds smoothly.

ECA10590

CAUTION

If any damage is found or the front fork does not operate smoothly, have a Yamaha dealer check or repair it.

EAU23280

Checking the steering

Worn or loose steering bearings may cause danger. Therefore, the operation of the steering must be checked as follows at the intervals specified in the periodic maintenance and lubrication chart.

1. Place a stand under the engine to raise the front wheel off the ground.

PERIODIC MAINTENANCE AND MINOR REPAIR

WARNING

EWA10750

Securely support the motorcycle so that there is no danger of it falling over.

2. Hold the lower ends of the front fork legs and try to move them forward and backward. If any free play can be felt, have a Yamaha dealer check or repair the steering.

EAU23290

Checking the wheel bearings

The front and rear wheel bearings must be checked at the intervals specified in the periodic maintenance and lubrication chart. If there is play in the wheel hub or if the wheel does not turn smoothly, have a Yamaha dealer check the wheel bearings.

Battery

EAU23320

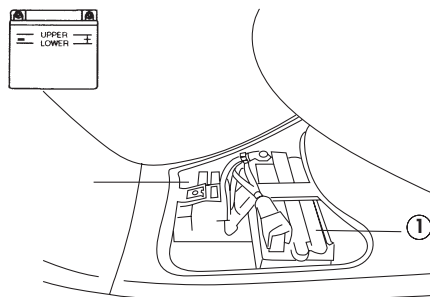

1. Battery

A poorly maintained battery will corrode and discharge quickly. The electrolyte level, battery lead connections and breather hose routing should be checked before each ride and at the intervals specified in the periodic maintenance and lubrication chart.

To check the electrolyte level

1. Place the vehicle on a level surface and hold it in an upright position.

NOTE:

Make sure that the vehicle is positioned straight up when checking the electrolyte level.

2. Remove cowling A. (See page 6-5)
3. Check the electrolyte level in the battery.

NOTE:

The electrolyte should be between the minimum and maximum level marks.

4. If the electrolyte is at or below the minimum level mark, add distilled water to raise it to the maximum level mark.

PERIODIC MAINTENANCE AND MINOR REPAIR

⚠ WARNING

EWA10770

- **Electrolyte is poisonous and dangerous since it contains sulfuric acid, which causes severe burns. Avoid any contact with skin, eyes or clothing and always shield your eyes when working near batteries. In case of contact, administer the following FIRST AID.**
 - **EXTERNAL:** Flush with plenty of water.
 - **INTERNAL:** Drink large quantities of water or milk and immediately call a physician.
 - **EYES:** Flush with water for 15 minutes and seek prompt medical attention.
- **Batteries produce explosive hydrogen gas. Therefore, keep sparks, flames, cigarettes, etc., away from the battery and provide sufficient ventilation when charging it in an enclosed space.**

- **Take care not to spill electrolyte on the drive chain, as this may weaken it, shorten chain life and possibly result in an accident.**
- **KEEP THIS AND ALL BATTERIES OUT OF THE REACH OF CHILDREN.**

ECA10610

CAUTION

Use only distilled water, as tap water contains minerals that are harmful to the battery.

5. Check and, if necessary, tighten the battery lead connections and correct the breather hose routing.
6. Install the panel.

To store the battery

1. If the vehicle will not be used for more than one month, remove the battery, fully charge it, and then place it in a cool, dry place.
2. If the battery will be stored for more than two months, check the specific gravity of the electrolyte at least once a month and fully charge the battery whenever necessary.
3. Fully charge the battery before installation.
4. After installation, make sure that the battery leads are properly connected to the battery terminals and that the breather hose is properly routed, in good condition, and not obstructed.

PERIODIC MAINTENANCE AND MINOR REPAIR

CAUTION

ECA10600

If the breather hose is positioned in such a way that the frame is exposed to electrolyte or gas expelled from the battery, the frame could suffer structural and external damages.

Replacing the fuse

EAUS1180

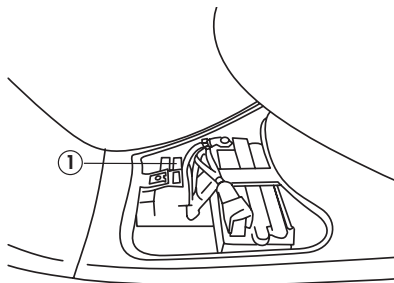

1. Main fuse

The fuse holder is located beside the battery case.

If the fuse is blown, replace it as follows.

1. Turn the key to “OFF” and turn off all electrical circuits.
2. Remove the blown fuse, and then install a new fuse of the specified amperage.

Specified fuse:

20 A

CAUTION

ECA10640

Do not use a fuse of a higher amperage rating than recommended to avoid causing extensive damage to the electrical system and possibly a fire.

3. Turn the key to “ON” and turn on the electrical circuits to check if the devices operate.
4. If the fuse immediately blows again, have a Yamaha dealer check the electrical system.

EAUS1110

Replacing the headlight bulb or a front turn signal light bulb

If a bulb burns out, replace it as follows.

ECA10670

CAUTION

It is advisable to have a Yamaha dealer perform this job.

Headlight bulb

1. Remove the front panel by removing the screws.

EWA10790

⚠ WARNING

Headlight bulbs get very hot. Therefore, keep flammable products away from a lit headlight bulb, and do not touch the bulb until it has cooled down.

2. Remove the defective bulb from the socket.
3. Insert a new bulb into the socket.

PERIODIC MAINTENANCE AND MINOR REPAIR

4. Install the panel by installing the screws.
5. Have a Yamaha dealer adjust the headlight beam if necessary.

Front turn signal light bulb

1. Remove the front panel by removing the screws.
2. Remove the defective bulb from the socket.
3. Insert a new bulb into the socket.
4. Install the panel by installing the screws.

EAU24250

6 Replacing a front turn signal light bulb

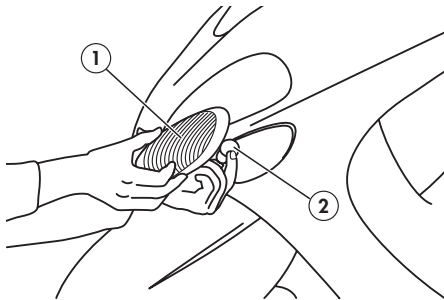

1. Lens front turn signal
2. Light bulb

1. Remove the front turn signal light lens by removing the screw.
2. Remove the defective bulb by pushing it in and turning it counterclockwise.
3. Insert a new bulb into the socket, push it in, and then turn it clockwise until it stops.
4. Install the lens by installing the screw.

CAUTION

ECA11190

Do not overtighten the screw, otherwise the lens may break.

EAU24310

Replacing the license plate light bulb

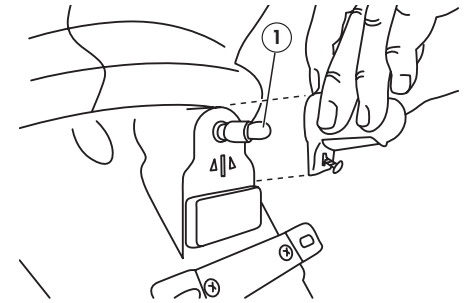

1. License plate light

1. Remove the license plate light unit by removing the screws.
2. Remove the socket (together with the bulb) by pulling it out.
3. Remove the defective bulb by pulling it out.
4. Insert a new bulb into the socket.
5. Install the socket (together with the bulb) by pushing it in.
6. Install the license plate light unit by installing the screws.

EAUS1130

Replacing the tail/brake light bulb or a rear turn signal light bulb

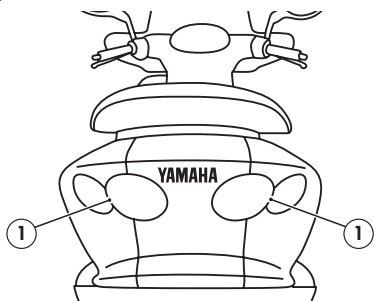

1. Screw (x2)

Tail/brake light bulb

1. Remove the tail/brake light bulb lens by removing the screws.
2. Remove the defective bulb by pushing it in and turning it counterclockwise.
3. Insert a new bulb into the socket, push it in, and then turn it clockwise until it stops.
4. Install the lens by installing the screws.

Rear turn signal light bulb

1. Remove the tail/brake light lens by removing the screws.
2. Remove the left or right turn signal light bulb lens by pulling it backwards.
3. Remove the defective bulb by pushing it in and turning it counterclockwise.
4. Insert a new bulb into the socket, push it in, and then turn it clockwise until it stops.
5. Install the turn signal light bulb lens.
6. Install the tail/brake light bulb lens by installing the screws.

ECA10680

CAUTION

Do not overtighten the screws, otherwise the lens may break.

PERIODIC MAINTENANCE AND MINOR REPAIR

EAU25880

Troubleshooting

Although Yamaha scooters receive a thorough inspection before shipment from the factory, trouble may occur during operation. Any problem in the fuel, compression, or ignition systems, for example, can cause poor starting and loss of power.

The following troubleshooting charts represent quick and easy procedures for checking these vital systems yourself. However, should your scooter require any repair, take it to a Yamaha dealer, whose skilled technicians have the necessary tools, experience, and know-how to service the scooter properly.

Use only genuine Yamaha replacement parts. Imitation parts may look like Yamaha parts, but they are often inferior, have a shorter service life and can lead to expensive repair bills.

PERIODIC MAINTENANCE AND MINOR REPAIR

EAU25962

Troubleshooting chart

EWA10840



WARNING

Keep away from open flames and do not smoke while checking or working on the fuel system.

1. Fuel

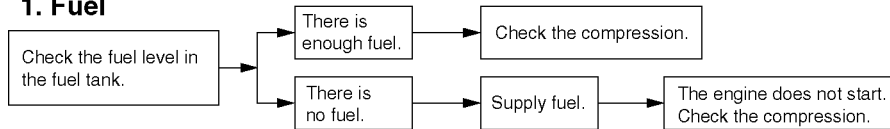

2. Compression

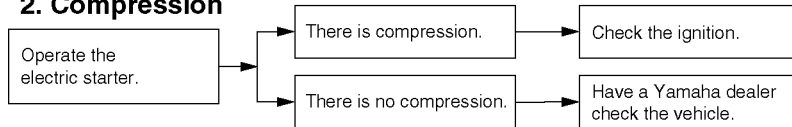

3. Ignition

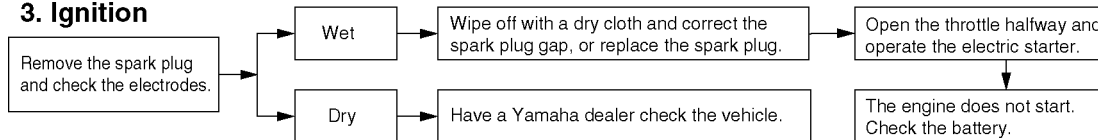

4. Battery

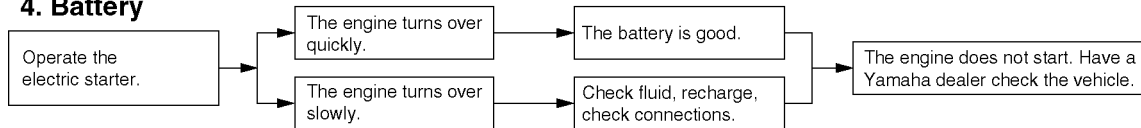

SCOOTER CARE AND STORAGE

EAU26090

Care

While the open design of a scooter reveals the attractiveness of the technology, it also makes it more vulnerable. Rust and corrosion can develop even if high-quality components are used. A rusty exhaust pipe may go unnoticed on a car, however, it detracts from the overall appearance of a scooter. Frequent and proper care does not only comply with the terms of the warranty, but it will also keep your scooter looking good, extend its life and optimize its performance.

Before cleaning

1. Cover the muffler outlet with a plastic bag after the engine has cooled down.
2. Make sure that all caps and covers as well as all electrical couplers and connectors, including the spark plug cap, are tightly installed.
3. Remove extremely stubborn dirt, like oil burnt onto the crankcase, with a degreasing agent and a brush, but never apply such pro-

ducts onto seals, gaskets and wheel axles. Always rinse the dirt and degreaser off with water.

Cleaning

ECA10780

CAUTION

- **Avoid using strong acidic wheel cleaners, especially on spoked wheels. If such products are used on hard-to-remove dirt, do not leave the cleaner on the affected area any longer than instructed. Also, thoroughly rinse the area off with water, immediately dry it, and then apply a corrosion protection spray.**
- **Improper cleaning can damage windshields, cowlings, panels and other plastic parts. Use only a soft, clean cloth or sponge with mild detergent and water to clean plastic.**
- **Do not use any harsh chemical products on plastic parts. Be sure to avoid using cloths or sponges which have been in contact with strong or abrasive cleaning products, solvent or**

thinner, fuel (gasoline), rust removers or inhibitors, brake fluid, antifreeze or electrolyte.

- **Do not use high-pressure washers or steam-jet cleaners since they cause water seepage and deterioration in the following areas: seals (of wheel and swingarm bearings, fork and brakes), electric components (couplers, connectors, instruments, switches and lights), breather hoses and vents.**
 - **For scooters equipped with a windshield: Do not use strong cleaners or hard sponges as they will cause dulling or scratching. Some cleaning compounds for plastic may leave scratches on the windshield. Test the product on a small hidden part of the windshield to make sure that it does not leave any marks. If the windshield is scratched, use a quality plastic polishing compound after washing.**
-

SCOOTER CARE AND STORAGE

After normal use

Remove dirt with warm water, a mild detergent, and a soft, clean sponge, and then rinse thoroughly with clean water. Use a toothbrush or bottle-brush for hard-to-reach areas. Stubborn dirt and insects will come off more easily if the area is covered with a wet cloth for a few minutes before cleaning.

After riding in the rain, near the sea or on salt-sprayed roads

Since sea salt or salt sprayed on the roads during winter are extremely corrosive in combination with water, carry out the following steps after each ride in the rain, near the sea or on salt-sprayed roads.

NOTE:

Salt sprayed on roads in the winter may remain well into spring.

1. Clean the scooter with cold water and a mild detergent after the engine has cooled down.

ECA10790

CAUTION

Do not use warm water since it increases the corrosive action of the salt.

2. Apply a corrosion protection spray on all metal, including chrome- and nickel-plated, surfaces to prevent corrosion.

After cleaning

1. Dry the scooter with a chamois or an absorbing cloth.
2. Use a chrome polish to shine chrome, aluminum and stainless-steel parts, including the exhaust system. (Even the thermally induced discoloring of stainless-steel exhaust systems can be removed through polishing.)
3. To prevent corrosion, it is recommended to apply a corrosion protection spray on all metal, including chrome- and nickel-plated, surfaces.
4. Use spray oil as a universal cleaner to remove any remaining dirt.
5. Touch up minor paint damage caused by stones, etc.

6. Wax all painted surfaces.
7. Let the scooter dry completely before storing or covering it.

EWA10940

⚠ WARNING

- **Make sure that there is no oil or wax on the brakes or tires. If necessary, clean the brake discs and brake linings with a regular brake disc cleaner or acetone, and wash the tires with warm water and a mild detergent.**
- **Before operating the scooter test its braking performance and cornering behavior.**

ECA10800

CAUTION

- **Apply spray oil and wax sparingly and make sure to wipe off any excess.**
- **Never apply oil or wax to any rubber and plastic parts, but treat them with a suitable care product.**
- **Avoid using abrasive polishing compounds as they will wear away the paint.**

SCOOTER CARE AND STORAGE

NOTE: _____
Consult a Yamaha dealer for advice on what products to use.

EAU26300

Storage Short-term

Always store your scooter in a cool, dry place and, if necessary, protect it against dust with a porous cover.

ECA10820

CAUTION

- **Storing the scooter in a poorly ventilated room or covering it with a tarp, while it is still wet, will allow water and humidity to seep in and cause rust.**
- **To prevent corrosion, avoid damp cellars, stables (because of the presence of ammonia) and areas where strong chemicals are stored.**

Long-term

Before storing your scooter for several months:

1. Follow all the instructions in the “Care” section of this chapter.

2. Drain the carburetor float chamber by loosening the drain bolt; this will prevent fuel deposits from building up. Pour the drained fuel into the fuel tank.
3. Fill up the fuel tank and add fuel stabilizer (if available) to prevent the fuel tank from rusting and the fuel from deteriorating.
4. Perform the following steps to protect the cylinder, piston rings, etc. from corrosion.
 - a. Remove the spark plug cap and spark plug.
 - b. Pour a teaspoonful of engine oil into the spark plug bore.
 - c. Install the spark plug cap onto the spark plug, and then place the spark plug on the cylinder head so that the electrodes are grounded. (This will limit sparking during the next step.)
 - d. Turn the engine over several times with the starter. (This will coat the cylinder wall with oil.)
 - e. Remove the spark plug cap from the spark plug, and then install the spark plug and the spark plug cap.

WARNING

EWA10950

To prevent damage or injury from sparking, make sure to ground the spark plug electrodes while turning the engine over.

5. Lubricate all control cables and the pivoting points of all levers and pedals as well as of the sidestand/centerstand.
6. Check and, if necessary, correct the tire air pressure, and then lift the scooter so that both of its wheels are off the ground. Alternatively, turn the wheels a little every month in order to prevent the tires from becoming degraded in one spot.
7. Cover the muffler outlet with a plastic bag to prevent moisture from entering it.
8. Remove the battery and fully charge it. Store it in a cool, dry place and charge it once a month. Do not store the battery in an excessively cold or warm place [less than 0 °C (30 °F) or more than 30 °C (90 °F)]. For more

SCOOTER CARE AND STORAGE

information on storing the battery, see page 6-18.

NOTE: _____
Make any necessary repairs before
storing the scooter.

SPECIFICATIONS

Dimensions

Overall length	2030 mm
Overall width	745 mm
Overall height	1285 mm
Seat height	774 mm
Wheelbase	1480 mm
Ground clearance	102 mm
Minimum turning radius	102 mm

Weight

With oil and fuel	142 kg
-------------------	--------

Engine

Engine type	Liquid cooled 4-stroke, SOHC
Cylinder arrangement	Forward-inclined single cylinder
Displacement	124.1 cm ³ 175.6 cm ³
Bore x stroke	53.7 x 54.8 mm 62.2 x 57.8 mm
Compression ratio	11 : 1 11 : 1
Starting system	Electric starter

Lubrication system	Wet sump
--------------------	----------

Engine oil

Type	SAE10W30 or SAE10W40 SE type
------	------------------------------

Engine oil quantity

Periodic oil change	1.30 L
---------------------	--------

Transmission oil

Type	YAMALUBE 4 (10W30) or SAE10W30 type SE motor oil
------	--

Cooling system

Coolant reservoir capacity (up to the maximum level mark)	0.60 L
---	--------

Air filter

Air filter element	Dry element
--------------------	-------------

Fuel

Recommended fuel	Regular unleaded gasoline only
Fuel tank capacity	10.5 L

Carburetor

Manufacturer	TEIKEI
Type x quantity	TK28 x 1 TK28 x 1

Spark plug (s)

Manufacturer/model	NGK/CR8E
--------------------	----------

Spark plug gap	0.7-0.8 mm
----------------	------------

Clutch

Clutch type	Dry, centrifugal automatic
-------------	----------------------------

Transmission

Primary reduction system	Helical gear
Primary reduction ratio	40/15 (2.666)
Secondary reduction system	Helical gear
Secondary reduction ratio	44/12 (3.666)
Transmission type	V-belt automatic

Chassis

Frame type	Steel tube underbone
Caster angle	28.00 degree
Trail	104.0 mm

Front tire

Type	Tubeless
Size	120/70-12 47L
Manufacturer/model	MICHELIN CHENG SHIN PIRELLI

Rear tire

Type

Tubeless

Size

130/70-12 51L

Manufacturer/model

MICHELIN

GHENG SING

PIRELLI

Loading

Maximum load

183 kg

183 kg

Tire air pressure (measured on cold tires)

Front

190 kPa

Rear

220 kPa

Front wheel

Wheel type

Cast wheel

Rim size

12 x MT3.50

Rear wheel

Wheel type

Cast wheel

Rim size

12 x MT3.50

Front brake

Type

Single disc brake

Operation

Right hand operation

Recommended fluid

DOT 4

Rear brake

Type

Single disc brake

Operation

Left hand operation

Recommended fluid

DOT 4

Front suspension

Type

Telescopic fork

Spring/shock absorber type

Coil spring/oil damper

Wheel travel

90.0 mm

Rear suspension

Type

Unit swing

Spring/shock absorber type

Coil spring/oil damper

Wheel travel

90 mm

Electrical system

Ignition system

CDI

Charging system

AC magneto

Battery

Model

CB7L-B2

Voltage, capacity

12 V, 8 Ah

Bulb voltage, wattage x quantity

Headlight

12 V, 35 W / 35 W x 2

Tail/brake light

12 V, 21 W / 5 W x 2

Front turn signal light

12 V, 21 W x 2

Rear turn signal light

12 V, 10 W x 2

Meter lighting

12 V, 1.2 W x 2

High beam indicator light

12 V, 1.2 W x 1

Oil level warning light

LED

Fuel level warning light

NONE

Fuses

Main fuse

20 A

Radiator fan fuse

4 A

Reserve fuse

20 A

Reserve fuse

4 A

CONSUMER INFORMATION

EAU26351

Identification numbers

Record the key identification number, vehicle identification number and model label information in the spaces provided below for assistance when ordering spare parts from a Yamaha dealer or for reference in case the vehicle is stolen.

KEY IDENTIFICATION NUMBER

VEHICLE IDENTIFICATION NUMBER:

MODEL LABEL INFORMATION:

Key identification number

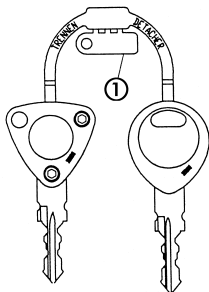

1. Key identification number

The key identification number is stamped into the key tag. Record this number in the space provided and use it for reference when ordering a new key.

EAU26381

Vehicle identification number

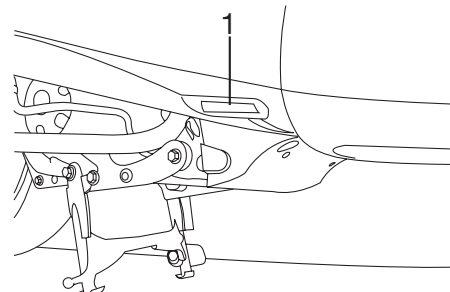

1. Vehicle identification number

The vehicle identification number is stamped into the frame.

NOTE: _____

The vehicle identification number is used to identify your motorcycle and may be used to register your motorcycle with the licensing authority in your area.

EAU26410

EAU26490

Model label

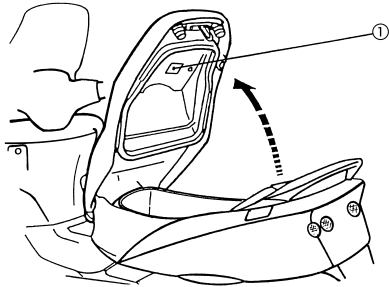

1. Model label

The model label is affixed to the bottom of the seat. (See page 3-7.) Record the information on this label in the space provided. This information will be needed when ordering spare parts from a Yamaha dealer.

INDEX

A	
Acceleration and deceleration	5-2
Adjusting the brake lever free play	6-15
Adjusting the carburetor	6-12
Adjusting the rear shock absorber assemblies	3-8
Air filter and V-belt case air filter elements	6-11
B	
Battery	6-18
Battery voltage/fuel gauge	3-3
Braking	5-2
C	
Care	7-1
Clock	3-4
Controls and Instruments	2-3
Coolant	6-10
Changing the brake fluid	6-16
Checking and lubricating the cables	6-16
Checking and lubricating the centerstand and sidestand	6-17
Checking the brake fluid level	6-15
Checking the front and rear brake pads	6-15
Checking the front fork	6-17
Checking the spark plug	6-6
Checking the steering	6-17
Checking the throttle cable free play	6-12
Checking the wheel bearings	6-18
E	
Engine oil	6-7
F	
Final gear oil	6-9
Front brake lever	3-5
Front storage compartment	3-7
Fuel	3-6
Fuel tank cap	3-6
H	
Handlebar switches	3-4
I	
Identification numbers	9-1
Indicator lights	3-1
L	
Left view	2-1
M	
Main switch	3-1
Model label	9-2
O	
Owner's tool kit	6-1
P	
Parking	5-3
Periodic maintenance and lubrication chart	6-2
Pre-operation check list	4-2
R	
Rear brake lever	3-6
Removing and installing cowlings and panels	6-5
Replacing a front turn signal light bulb	6-21
Replacing the fuse	6-20
Replacing the headlight bulb or a front turn signal light bulb	6-20
Replacing the license plate light bulb	6-21
Replacing the tail/brake light bulb or a rear turn signal light bulb	6-22
Right view	2-2
S	
Seat	3-7
Sidestand	3-8

Sidestand switch operation check	3-9
Speedometer unit	3-3
Starting a cold engine	5-1
Starting off	5-2
Storage	7-3
Storage compartment	3-7
T	
Tires	6-13
Troubleshooting	6-23
Troubleshooting chart	6-24



PRINTED IN SPAIN
2005.09-Bengar Gràfiques, S.L.
(E)