



OWNER'S MANUAL

Drag Star

**XVS650
XVS650A
4VR-28199-E3**

Welcome to the Yamaha world of motorcycling!

As the owner of a XVS650/XVS650A, you are benefiting from Yamaha's vast experience in and newest technology for the design and the manufacture of high-quality products, which have earned Yamaha a reputation for dependability.

Please take the time to read this manual thoroughly, so as to enjoy all your XVS650/XVS650A's advantages. The owner's manual does not only instruct you in how to operate, inspect and maintain your motorcycle, but also in how to safeguard yourself and others from trouble and injury.

In addition, the many tips given in this manual will help to keep your motorcycle in the best possible condition. If you have any further questions, do not hesitate to contact your Yamaha dealer.

The Yamaha team wishes you many safe and pleasant rides. So, remember to put safety first!

IMPORTANT MANUAL INFORMATION

EAU00005

Particularly important information is distinguished in this manual by the following notations:



The Safety Alert Symbol means **ATTENTION! BECOME ALERT! YOUR SAFETY IS INVOLVED!**



Failure to follow **WARNING** instructions could result in severe injury or death to the motorcycle operator, a bystander or a person inspecting or repairing the motorcycle.

CAUTION:

A **CAUTION** indicates special precautions that must be taken to avoid damage to the motorcycle.

NOTE:

A **NOTE** provides key information to make procedures easier or clearer.

NOTE:

- This manual should be considered a permanent part of this motorcycle and should remain with it even if the motorcycle is subsequently sold.
 - Yamaha continually seeks advancements in product design and quality. Therefore, while this manual contains the most current product information available at the time of printing, there may be minor discrepancies between your motorcycle and this manual. If there is any question concerning this manual, please consult your Yamaha dealer.
-

IMPORTANT MANUAL INFORMATION

EW000002



PLEASE READ THIS MANUAL CAREFULLY AND COMPLETELY BEFORE OPERATING THIS MOTORCYCLE.

EAU00008

**XVS650/XVS650A
OWNER'S MANUAL**

© 1999 by Yamaha Motor Co., Ltd.

1st Edition, May 1999

**All rights reserved. Any reprinting or
unauthorized use without the written
permission of Yamaha Motor Co., Ltd.
is expressly prohibited.**

Printed in Japan.

1 GIVE SAFETY THE RIGHT OF WAY	1
2 DESCRIPTION	2
3 INSTRUMENT AND CONTROL FUNCTIONS	3
4 PRE-OPERATION CHECKS	4
5 OPERATION AND IMPORTANT RIDING POINTS	5
6 PERIODIC MAINTENANCE AND MINOR REPAIR	6
7 MOTORCYCLE CARE AND STORAGE	7
8 SPECIFICATIONS	8
9 CONSUMER INFORMATION	9
INDEX	



GIVE SAFETY THE RIGHT OF WAY

GIVE SAFETY THE RIGHT OF WAY 1-1



1

Motorcycles are fascinating vehicles, which can give you an unsurpassed feeling of power and freedom. However, they also impose certain limits, which you must accept; even the best motorcycle does not ignore the laws of physics.

Regular care and maintenance are essential for preserving your motorcycle's value and operating condition. Moreover, what is true for the motorcycle is also true for the rider: good performance depends on being in good shape. Riding under the influence of medication, drugs and alcohol is, of course, out of the question. Motorcycle riders – more than car drivers – must always be at their mental and physical best. Under the influence of even small amounts of alcohol, there is a tendency to take dangerous risks.

Protective clothing is as essential for the motorcycle rider as seat belts are for car drivers and passengers. Always wear a complete motorcycle suit (whether made of leather or tear-resistant synthetic materials with protectors), sturdy boots, motorcycle gloves and a properly fitting helmet. Optimum protective wear, however, should not encourage carelessness. Though full-coverage helmets and suits, in particular, create an illusion of total safety and protection, motorcyclists will always be vulnerable. Riders who lack critical self-control run the risk of going too fast and are apt to take chances. This is even more dangerous in wet weather. The good motorcyclist rides safely, predictably and defensively – avoiding all dangers, including those caused by others.

Enjoy your ride!

Left view (XVS650)	2-1
Right view (XVS650).....	2-2
Left view (XVS650A).....	2-3
Right view (XVS650A)	2-4
Controls/Instruments (XVS650/XVS650A).....	2-5

Left view (XVS650)

2

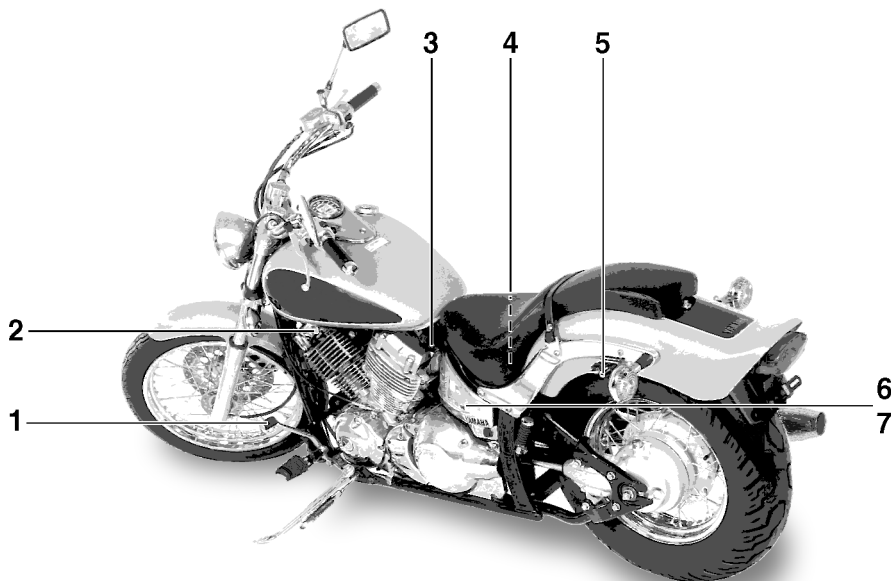

- | | |
|--|-------------|
| 1. Shift pedal | (page 3-5) |
| 2. Fuel cock | (page 3-8) |
| 3. Starter (choke) “  ” | (page 3-9) |
| 4. Rear shock absorber spring preload adjusting ring | (page 3-14) |
| 5. Helmet holder | (page 3-12) |
| 6. Storage compartment | (page 3-13) |
| 7. Tool kit | (page 6-1) |

Right view (XVS650)



- | | |
|----------------------|-------------|
| 8. Oil filter | (page 6-10) |
| 9. Battery | (page 6-26) |
| 10. Fuses | (page 6-27) |
| 11. Main switch | (page 3-1) |
| 12. Air filter | (page 6-12) |
| 13. Rear brake pedal | (page 3-6) |

DESCRIPTION

Left view (XVS650A)

2

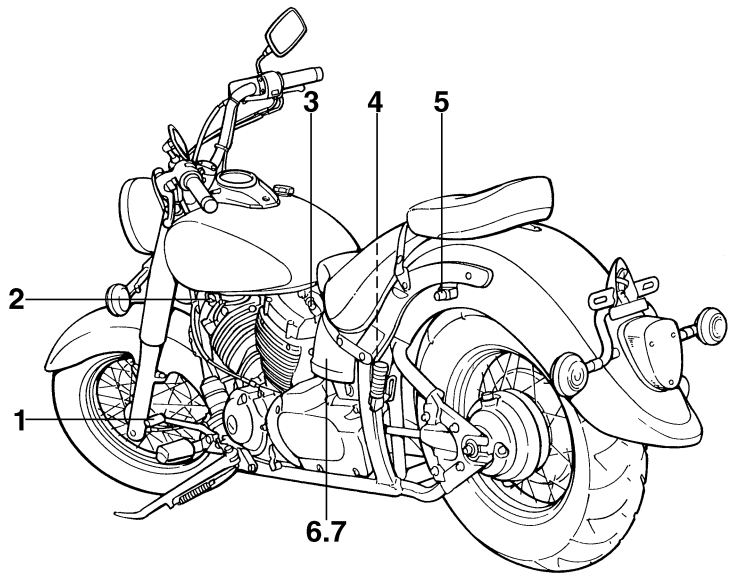

- | | |
|--|-------------|
| 1. Shift pedal | (page 3-5) |
| 2. Fuel cock | (page 3-8) |
| 3. Starter (choke) “ \ ” | (page 3-9) |
| 4. Rear shock absorber spring preload adjusting ring | (page 3-14) |
| 5. Helmet holder | (page 3-12) |
| 6. Storage compartment | (page 3-13) |
| 7. Tool kit | (page 6-1) |

Right view (XVS650A)

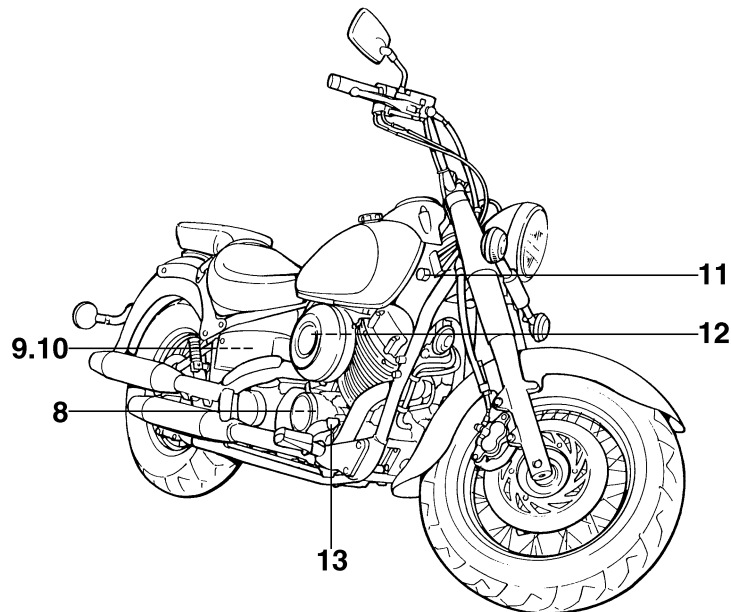

- 8. Oil filter (page 6-10)
- 9. Battery (page 6-26)
- 10. Fuses (page 6-27)
- 11. Main switch (page 3-1)
- 12. Air filter (page 6-12)
- 13. Rear brake pedal (page 3-6)

DESCRIPTION

Controls/Instruments (XVS650/XVS650A)

2

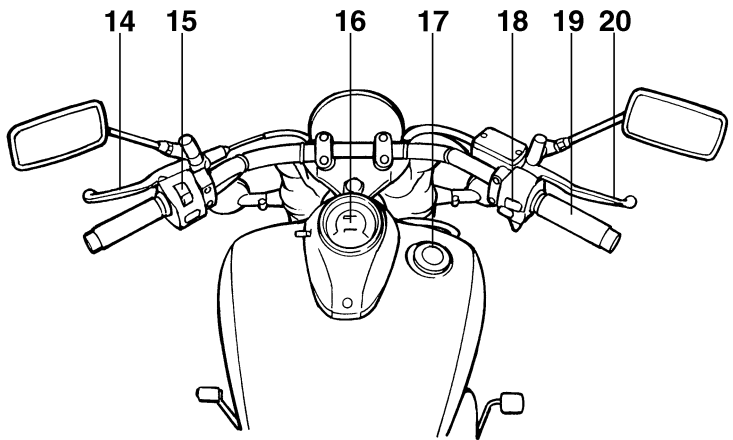

- | | |
|------------------------------|-------------|
| 14. Clutch lever | (page 3-5) |
| 15. Left handlebar switches | (page 3-3) |
| 16. Speedometer | (page 3-2) |
| 17. Fuel tank cap | (page 3-6) |
| 18. Right handlebar switches | (page 3-4) |
| 19. Throttle grip | (page 6-15) |
| 20. Front brake lever | (page 3-5) |

INSTRUMENT AND CONTROL FUNCTIONS

Main switch/Steering lock.....	3-1
Indicator lights	3-2
Speedometer	3-2
Antitheft alarm (optional).....	3-3
Handlebar switches.....	3-3
Clutch lever	3-5
Shift pedal	3-5
Front brake lever	3-5
Rear brake pedal.....	3-6
Fuel tank cap	3-6
Fuel	3-7
Fuel tank breather hose	3-7
Fuel cock.....	3-8
Starter (choke) “ ↘ ”	3-9
Seats (for XVS650)	3-9
Seats (for XVS650A).....	3-11
Helmet holder.....	3-12
Storage compartment	3-13
Rear shock absorber adjustment	3-14
Luggage strap holders	3-15
Sidestand	3-15
Sidestand/clutch switch operation check	3-16

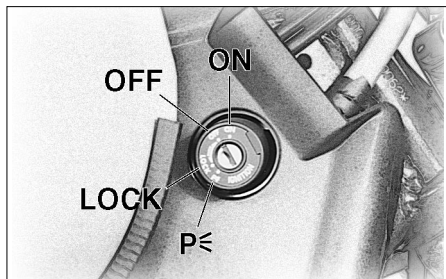

EAU00029

Main switch/Steering lock

The main switch controls the ignition and lighting systems. Its operation is described below.

EAU00036

ON

Electrical circuits are switched on. The engine can be started. The key cannot be removed in this position.

EAU00038

OFF

All electrical circuits are switched off. The key can be removed in this position.

EAU00040

LOCK

The steering is locked in this position and all electrical circuits are switched off.

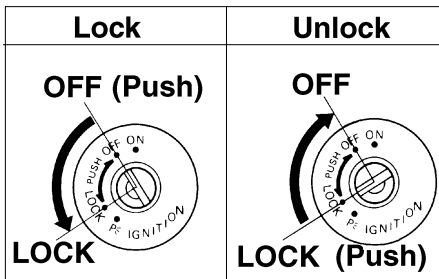

The key can be removed in this position. To lock the steering, turn the handlebars all the way to the left. While pushing the key into the main switch, turn it from “OFF” to “LOCK” and remove it. To release the lock, turn the key to “OFF” while pushing.

EW000016

⚠ WARNING

Never turn the key to “OFF” or “LOCK” when the motorcycle is moving. The electrical circuits will be switched off which may result in loss of control or an accident. Be sure the motorcycle is stopped before turning the key to “OFF” or “LOCK”.

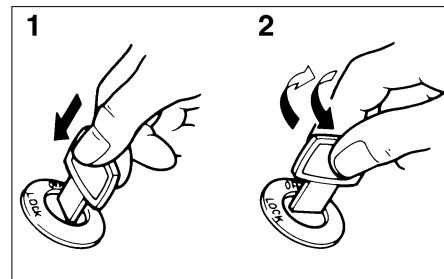

1. Push
2. Turn

EAU00044





P (Parking)

The steering is locked in this position and the taillight comes on, but all other circuits are off. The key can be removed in this position.

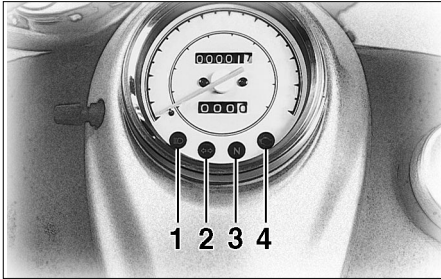
To use the parking position, first lock the steering, then turn the key to “P”. Do not use this position for an extended length of time as the battery may discharge.

INSTRUMENT AND CONTROL FUNCTIONS



1. High beam indicator light “”
2. Turn indicator light “ ”
3. Neutral indicator light “**N**”
4. Engine trouble indicator light “”

Indicator lights

EAU00056

1. Turn indicator light “ ”

EAU00057

This indicator flashes when the turn switch is moved to the left or right.

2. Neutral indicator light “**N**”

EAU00061

This indicator comes on when the transmission is in neutral.

3. High beam indicator light “”

EAU00063

This indicator comes on when the headlight high beam is used.

4. Engine trouble indicator light “”

EAU00091

This indicator light will come on or flash if trouble occurs in a monitoring circuit. In such a case, take the motorcycle to a Yamaha dealer to have the self-diagnostic systems checked.

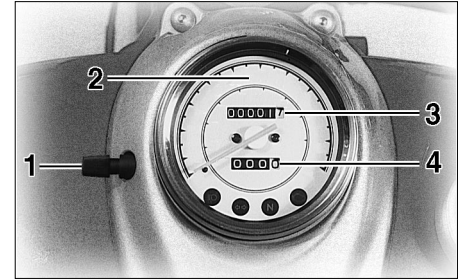

1. Reset knob
2. Speedometer
3. Odometer
4. Trip odometer

Speedometer

EAU00095

The speedometer shows riding speed. This speedometer is equipped with an odometer and trip odometer. The trip odometer can be reset to “0” with the reset knob. Use the trip odometer to estimate how far you can ride on a tank of fuel. This information will enable you to plan fuel stops in the future.

INSTRUMENT AND CONTROL FUNCTIONS

Antitheft alarm (optional)

EAU00109

An antitheft alarm can be equipped to this motorcycle. Consult your Yamaha dealer to obtain and install the alarm.

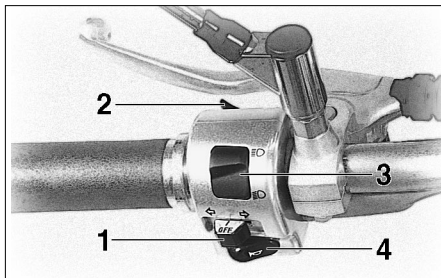

1. Turn signal switch
2. Pass switch “≡⊙”
3. Dimmer switch
4. Horn switch “🔔”

Handlebar switches

EAU00118

Turn signal switch

EAU00127

To signal a right-hand turn, push the switch to “⇨”. To signal a left-hand turn, push the switch to “⇧”. Once the switch is released it will return to the center position. To cancel the signal, push the switch in after it has returned to the center position.

Pass switch “≡⊙”

EAU00119

Press the switch to operate the passing light.

Dimmer switch

EAU00121

Turn the switch to “≡⊙” for the high beam and to “⊙” for the low beam.

Horn switch “🔔”

EAU00129

Press the switch to sound the horn.

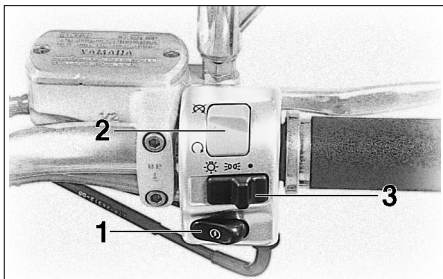

1. Start switch “

Start switch “ EAU00143

The starter motor cranks the engine when pushing the start switch.

EC000005

CAUTION:

See starting instructions prior to starting the engine.



EAU00138

Engine stop switch

The engine stop switch is a safety device for use in an emergency such as when the motorcycle overturns or if trouble occurs in the throttle system. Turn the switch to “

EAU00134

Lights switch

Turning the light switch to “  

3

INSTRUMENT AND CONTROL FUNCTIONS

3

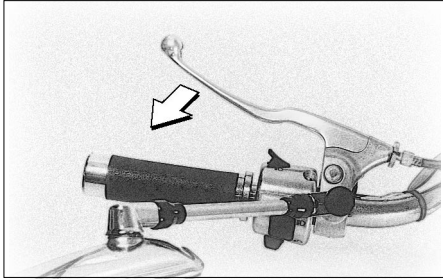

EAU00152

Clutch lever

The clutch lever is located on the left handlebar, and the ignition circuit cut-off system is incorporated in the clutch lever holder. Pull the clutch lever to the handlebar to disengage the clutch, and release the lever to engage the clutch. The lever should be pulled rapidly and released slowly for smooth clutch operation. (Refer to the engine starting procedures for a description of the ignition circuit cut-off system.)

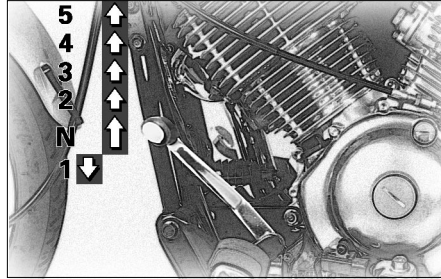

EAU00157

Shift pedal

This motorcycle is equipped with a constant-mesh 5-speed transmission. The shift pedal is located on the left side of the engine and is used in combination with the clutch when shifting.

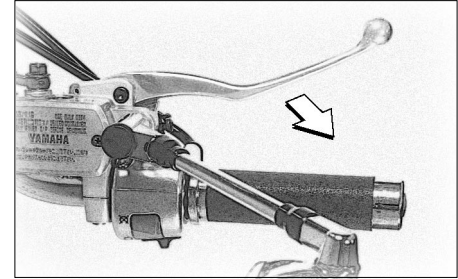

EAU00158

Front brake lever

The front brake lever is located on the right handlebar. Pull it toward the handlebar to apply the front brake.

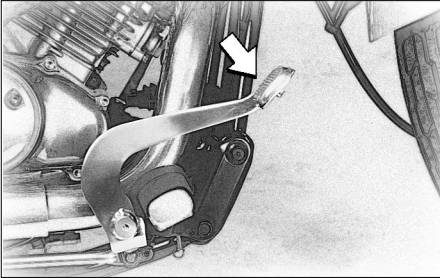

EAU00162

Rear brake pedal

The rear brake pedal is on the right side of the motorcycle. Press down on the brake pedal to apply the rear brake.

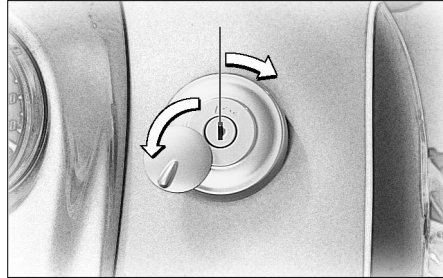

EAU00167

Fuel tank cap

To open

Insert the key and turn it 1/4 turn clockwise. The lock will be released and the cap can be opened.

To close

Push the tank cap into position with the key inserted. To remove the key, turn it counterclockwise to the original position.

NOTE:

This tank cap cannot be closed unless the key is in the lock. The key cannot be removed if the cap is not locked properly.

! WARNING

Be sure the cap is properly installed and locked in place before riding the motorcycle.

INSTRUMENT AND CONTROL FUNCTIONS

3

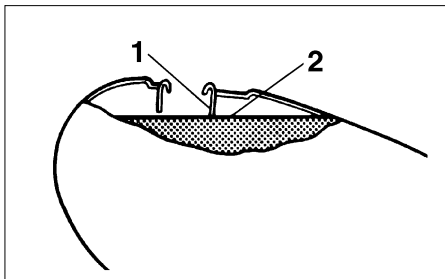

1. Filler tube
2. Fuel level

EAU01183

Fuel

Make sure there is sufficient fuel in the tank. Fill the fuel tank to the bottom of the filler tube as shown in the illustration.

EW000130

WARNING

Do not overfill the fuel tank. Avoid spilling fuel on the hot engine. Do not fill the fuel tank above the bottom of the filler tube or it may overflow when the fuel heats up later and expands.

EAU00185

CAUTION:

Always wipe off spilled fuel immediately with a dry and clean soft cloth. Fuel may deteriorate painted surfaces or plastic parts.

EAU00191

Recommended fuel:

Regular unleaded gasoline with a research octane number of 91 or higher.

Fuel tank capacity:

Total:

16 L

Reserve:

3 L

NOTE:

If knocking or pinging occurs, use a different brand of gasoline or higher octane grade.

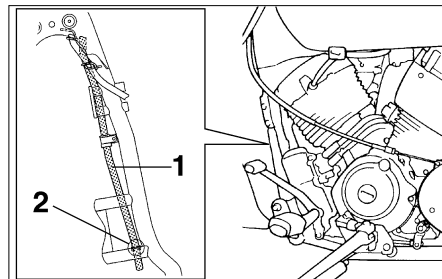

1. Fuel tank breather hose
2. Guide

EAU02955

Fuel tank breather hose

This model is equipped with a fuel tank breather hose.

Before using this motorcycle:

- Check the fuel tank breather hose connection.
- Check the fuel tank breather hose for cracks or damage and replace it if damaged.
- Make sure the end of the fuel tank breather hose is not blocked and clean it if necessary.

INSTRUMENT AND CONTROL FUNCTIONS

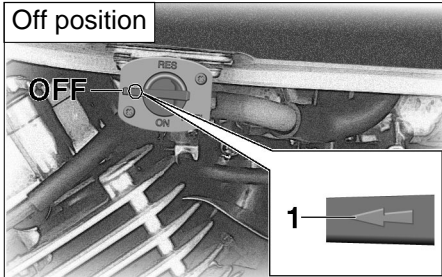

1. Arrow mark positioned over "OFF"

EAU02969

Fuel cock

The fuel cock supplies fuel from the tank to the carburetors while filtering it also.

The fuel cock has three positions, which should be set as shown in the illustrations.

OFF

With the fuel cock in this position, fuel will not flow. Always set the fuel cock to this position when the engine is not running.

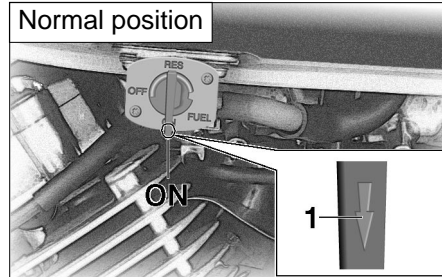

1. Arrow mark positioned over "ON"

ON

With the fuel cock in this position, fuel flows to the carburetors. Set the fuel cock to this position when starting the engine and while riding.

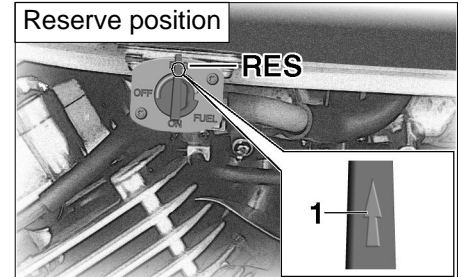

1. Arrow mark positioned over "RES"

RES

This indicates reserve. If you run out of fuel while riding, set the fuel cock to this position. Fill the tank at the first opportunity. Be sure to set the fuel cock back to "ON" after refueling!

INSTRUMENT AND CONTROL FUNCTIONS

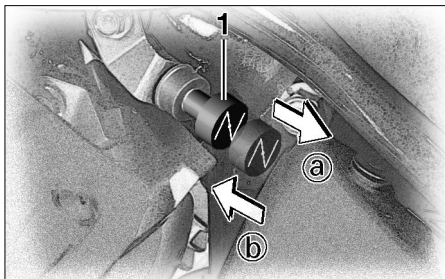

1. Starter (choke) “|↘|”

EAU02973

Starter (choke) “|↘|”

Starting a cold engine requires a richer air-fuel mixture. A separate starter circuit supplies this mixture.

Move in direction ① to turn on the starter (choke).

Move in direction ② to turn off the starter (choke).

ECA00038

CAUTION:

Do not use the starter (choke) for more than 3 minutes as the exhaust pipe may discolor from excessive heat. Also, longer use of the starter (choke) will cause afterburning. If afterburning occurs, turn off the starter (choke).

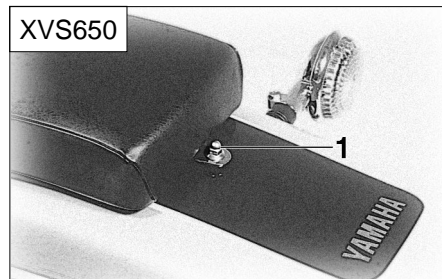

1. Nut

EAU01889

Seats (for XVS650)

Passenger seat

To remove

Remove the nut and pull the seat upward.

INSTRUMENT AND CONTROL FUNCTIONS

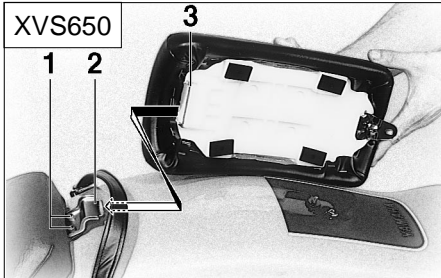

1. Bolt (× 2)
2. Seat holder
3. Projection

To install

Insert the projection on the front of the seat into the seat holder and install the nut.

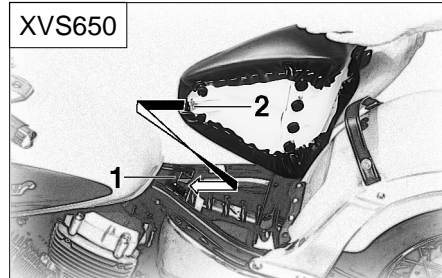

1. Seat holder
2. Projection

Rider seat

To remove

1. Remove the passenger seat.
2. Remove the two bolts and pull the seat upward.

To install

1. Insert the projection on the front of the seat into the seat holder and install the bolts.
2. Install the passenger seat.

NOTE: _____

Make sure that the seats are securely fitted.

INSTRUMENT AND CONTROL FUNCTIONS

3



1. Bolt

EAU01888

Seats (for XVS650A)

Passenger seat

To remove

Remove the bolt and pull the seat upward.

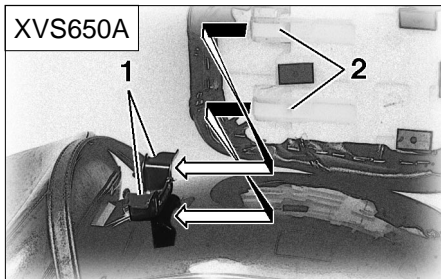

1. Seat holder
2. Projection (× 2)

To install

Insert the projections on the front of the seat into the holder and install the bolt.

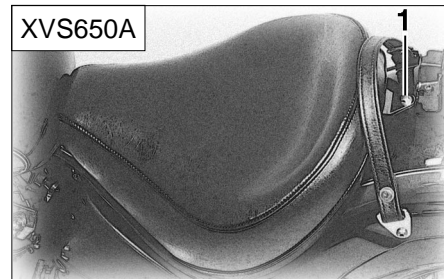

1. Bolt

Rider seat

To remove

1. Remove the passenger seat.
2. Remove the bolt and pull the seat upward.

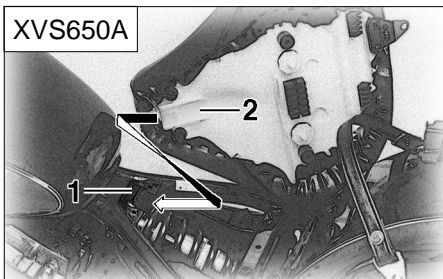

1. Seat holder
2. Projection

To install

1. Insert the projection on the front of the seat into the holder and install the bolt.
2. Install the passenger seat.

NOTE:

Make sure that the seats are securely fitted.

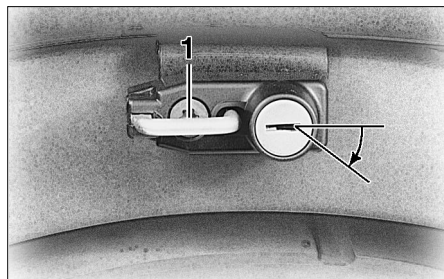

1. Helmet holder

EAU00260

Helmet holder

To open the helmet holder, insert the key in the lock and turn it as shown. To lock the helmet holder, replace the holder in its original position.

EW000030



Never ride with a helmet in the helmet holder. The helmet may hit objects, causing loss of control and possibly an accident.

INSTRUMENT AND CONTROL FUNCTIONS

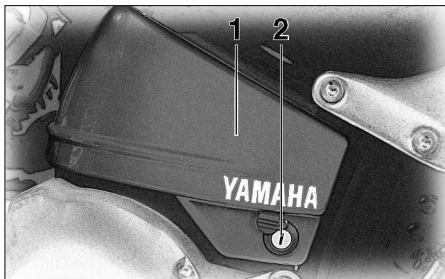

1. Compartment cover
2. Lock

Storage compartment

EAU01869

The storage compartment is located on the left side of the motorcycle.

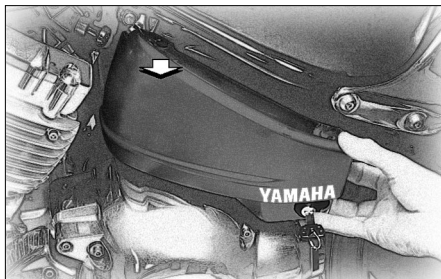

To open

Slide the lock cover open, insert the key in the lock and turn it clockwise. Then, pull the storage compartment cover out as shown.

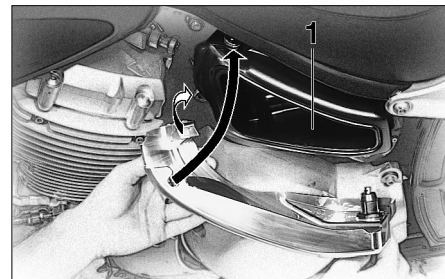

1. Storage compartment

To close

Place the storage compartment cover in its original position as shown. Then, turn the key counterclockwise and remove it. Close the lock cover.

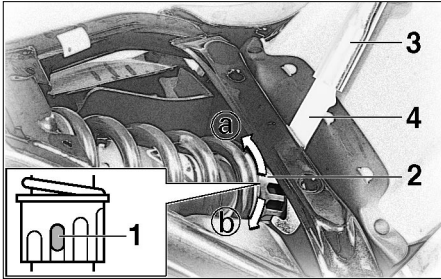

1. Position indicator
2. Adjusting ring
3. Extension bar
4. Special wrench

EAU00299*

Rear shock absorber adjustment

This shock absorber is equipped with a spring preload adjuster. Adjust spring preload as follows:

1. Remove the passenger seat and rider seat. (See page 3-9 for removal procedures.)

2. Use the special wrench and the extension bar in the owner's tool kit to turn the adjusting ring. Turn the adjusting ring in direction Ⓐ to increase spring preload and in direction Ⓑ to decrease spring preload. Make sure that the appropriate notch in the adjusting ring is aligned with the position indicator on the rear shock absorber.

Adjusting position	Soft		Standard	Hard			
	1	2	3	4	5	6	7

3. Install the seats.

⚠ WARNING

This shock absorber contains highly pressurized nitrogen gas. Read and understand the following information before handling the shock absorber. The manufacturer cannot be held responsible for property damage or personal injury that may result from improper handling.

- Do not tamper with or attempt to open the cylinder assembly.
- Do not subject the shock absorber to an open flame or other high heat source. This may cause the unit to explode due to excessive gas pressure.
- Do not deform or damage the cylinder in any way. Cylinder damage will result in poor damping performance.
- Take your shock absorber to a Yamaha dealer for any service.

INSTRUMENT AND CONTROL FUNCTIONS

EAU00330

EW000044

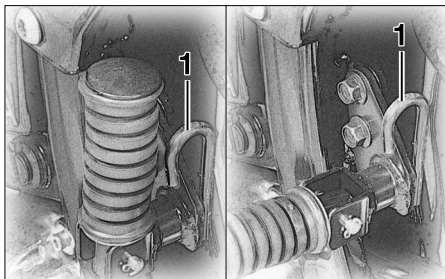

1. Luggage strap holder (× 2)

EAU01172

Luggage strap holders

There is a luggage strap holder located at each passenger footrest.

Sidestand

This model is equipped with an ignition circuit cut-off system. The motorcycle must not be ridden when the sidestand is down. The sidestand is located on the left side of the frame. (Refer to page 5-1 for an explanation of this system.)

WARNING

This motorcycle must not be operated with the sidestand in the down position. If the stand is not properly retracted, it could contact the ground and distract the operator, resulting in a possible loss of control. Yamaha has designed into this motorcycle a lockout system to assist the operator in fulfilling the responsibility of retracting the sidestand. Please check carefully the operating instructions listed below and if there is any indication of a malfunction, return the motorcycle to a Yamaha dealer immediately for repair.

EAU00331

Sidestand/clutch switch operation check

Check the operation of the sidestand switch and clutch switch against the information below.

TURN THE MAIN SWITCH TO "ON" AND THE ENGINE STOP SWITCH TO "⏪".

TRANSMISSION IS IN GEAR AND SIDESTAND IS UP.

PULL IN CLUTCH LEVER AND PUSH THE START SWITCH.

ENGINE WILL START.

CLUTCH SWITCH IS OK.

SIDESTAND IS DOWN.

ENGINE WILL STALL.

SIDESTAND SWITCH IS OK.

EW000045

WARNING

If improper operation is noted, consult a Yamaha dealer immediately.

PRE-OPERATION CHECKS

Pre-operation check list..... 4-1

PRE-OPERATION CHECKS

EAU01114

Owners are personally responsible for their vehicle's condition. Your motorcycle's vital functions can start to deteriorate quickly and unexpectedly, even if it remains unused (for instance, if it is exposed to the elements). Any damage, fluid leak or loss of tire pressure could have serious consequences. Therefore, it is very important that, in addition to a thorough visual inspection, you check the following points before each ride.

EAU00340

PRE-OPERATION CHECK LIST

ITEM	CHECKS	PAGE
Front brake	<ul style="list-style-type: none">• Check operation, free play, fluid level and vehicle for fluid leakage.• Fill with DOT 4 brake fluid if necessary.	6-19 ~ 6-22
Rear brake	<ul style="list-style-type: none">• Check operation, condition and free play.• Adjust if necessary.	6-20 ~ 6-22
Clutch	<ul style="list-style-type: none">• Check operation, condition and free play.• Adjust if necessary.	6-18
Throttle grip and housing	<ul style="list-style-type: none">• Check for smooth operation.• Lubricate if necessary.	6-15, 6-23
Engine oil	<ul style="list-style-type: none">• Check oil level.• Fill with oil if necessary.	6-9 ~ 6-11
Final gear oil	<ul style="list-style-type: none">• Check vehicle for leakage.	6-11 ~ 6-12
Wheels and tires	<ul style="list-style-type: none">• Check tire pressure, wear, damage and spoke tightness.• Tighten spokes if necessary.	6-15 ~ 6-17
Control and meter cable	<ul style="list-style-type: none">• Check for smooth operation.• Lubricate if necessary.	6-23
Brake and shift pedal shafts	<ul style="list-style-type: none">• Check for smooth operation.• Lubricate if necessary.	6-23
Brake and clutch lever pivots	<ul style="list-style-type: none">• Check for smooth operation.• Lubricate if necessary.	6-24
Sidestand pivot	<ul style="list-style-type: none">• Check for smooth operation.• Lubricate if necessary.	6-24

4

PRE-OPERATION CHECKS

ITEM	CHECKS	PAGE
Chassis fasteners	<ul style="list-style-type: none">• Make sure that all nuts, bolts and screws are properly tightened.• Tighten if necessary.	—
Fuel tank	<ul style="list-style-type: none">• Check fuel level.• Fill with fuel if necessary.	3-7
Lights, signals and switches	<ul style="list-style-type: none">• Check for proper operation.	6-28 ~ 6-29

NOTE:

Pre-operation checks should be made each time the motorcycle is used. Such an inspection can be thoroughly accomplished in a very short time; and the added safety it assures is more than worth the time involved.

WARNING

If any item in the Pre-Operation Check is not working properly, have it inspected and repaired before operating the motorcycle.

OPERATION AND IMPORTANT RIDING POINTS

Starting the engine.....	5-1
Starting a warm engine.....	5-4
Shifting.....	5-4
Tips for reducing fuel consumption	5-5
Engine break-in.....	5-5
Parking.....	5-6

EAU00373

EAU01068

⚠ WARNING

- Before riding this motorcycle, become thoroughly familiar with all operating controls and their functions. Consult a Yamaha dealer regarding any control or function that you do not thoroughly understand.
- Never start your engine or let it run for any length of time in a closed area. The exhaust fumes are poisonous and can cause loss of consciousness and death within a short time. Always operate your motorcycle in an area with adequate ventilation.
- Before starting out, always be sure the sidestand is up. Failure to retract the sidestand completely can result in a serious accident when you try to turn a corner.

Starting the engine

NOTE: _____

This motorcycle is equipped with an ignition circuit cut-off system. The engine can be started only under one of the following conditions:

- The transmission is in neutral.
- The sidestand is up, the transmission is in gear and the clutch is disengaged.

The motorcycle must not be ridden when the sidestand is down.

EW000054

⚠ WARNING

Before going through the following steps, check the function of the sidestand switch and clutch switch. (Refer to page 3-16.)

OPERATION AND IMPORTANT RIDING POINTS

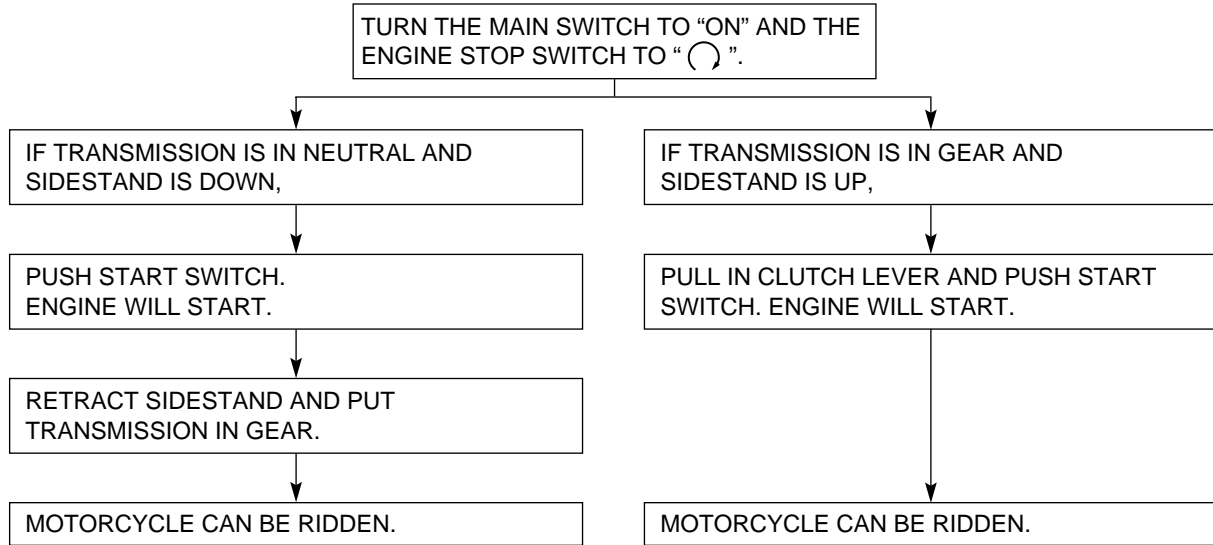

OPERATION AND IMPORTANT RIDING POINTS

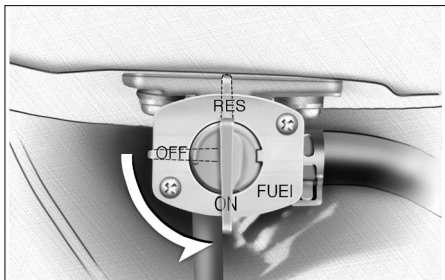

1. Turn the fuel cock to "ON".
2. Turn the main switch to "ON" and the engine stop switch to "⊙".
3. Shift transmission into neutral.

NOTE: _____

When the transmission is in neutral, the neutral indicator light should be on. If the light does not come on, ask a Yamaha dealer to inspect it.

4. Turn on the starter (choke) and completely close the throttle grip.
5. Start the engine by pushing the start switch.

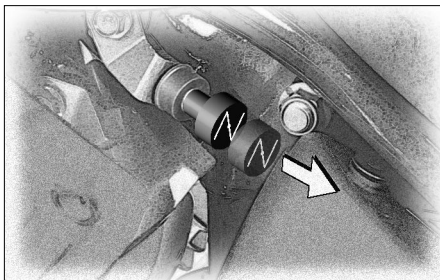

NOTE: _____

If the engine fails to start, release the start switch, wait a few seconds, then try again. Each attempt should be as short as possible to preserve the battery. Do not crank the engine more than 10 seconds on any one attempt.

6. After starting the engine, move the starter (choke) to the halfway position.

NOTE: _____

For maximum engine life, never accelerate hard with a cold engine!

7. After warming up the engine, turn off the starter (choke) completely.

NOTE: _____

The engine is warm when it responds normally to the throttle with the starter (choke) turned off.

OPERATION AND IMPORTANT RIDING POINTS

Starting a warm engine

EAU01258

The starter (choke) is not required when the engine is warm.

EC000046

CAUTION:

See the “Engine break-in” section prior to operating the motorcycle for the first time.

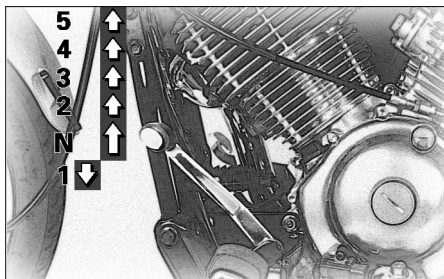

EAU00423

Shifting

The transmission lets you control the amount of power you have available at a given speed for starting, accelerating, climbing hills, etc. The use of the shift pedal is shown in the illustration.

To shift into neutral, depress the shift pedal repeatedly until it reaches the end of its travel, then raise the pedal slightly.

EC000048

CAUTION:

- Do not coast for long periods with the engine off, and do not tow the motorcycle a long distance. Even with gears in neutral, the transmission is only properly lubricated when the engine is running. Inadequate lubrication may damage the transmission.
- Always use the clutch when changing gears. The engine, transmission, and driveline are not designed to withstand the shock of forced shifting and can be damaged by shifting without using the clutch.

OPERATION AND IMPORTANT RIDING POINTS

Tips for reducing fuel consumption

EAU00424

Your motorcycle's fuel consumption depends to a large extent on your riding style. The following tips can help reduce fuel consumption:

- Warm up the engine before riding.
- Turn off the starter (choke) as soon as possible.
- Shift up swiftly and avoid high engine speeds during acceleration.
- Do not double-clutch or rev the engine while shifting down and avoid high engine speeds with no load on the engine.
- Turn off the engine instead of letting it idle for an extended length of time, i.e. in traffic jams, at traffic lights or railroad crossings.

Engine break-in

EAU01128

There is never a more important period in the life of your motorcycle than the period between zero and 1,600 km. For this reason we ask that you carefully read the following material. Because the engine is brand new, you must not put an excessive load on it for the first 1,600 km. The various parts in the engine wear and polish themselves to the correct operating clearances. During this period, prolonged full throttle operation, or any condition which might result in excessive heating of the engine, must be avoided.

0 ~ 1,000 km

EAU01171

Avoid operation above 1/3 throttle.

1,000 ~ 1,600 km

Avoid cruising speeds in excess of 1/2 throttle.

EC000056

CAUTION:

After 1,000 km of operation, be sure to replace the engine oil, oil filter and final gear oil.

1,600 km and beyond

Proceed with normal riding.

EC000049

CAUTION:

If any engine trouble should occur during the break-in period, consult a Yamaha dealer immediately.

EAU00457

Parking

When parking the motorcycle, stop the engine and remove the ignition key. Turn the fuel cock to “OFF” whenever stopping the engine.

EW000058

WARNING

The exhaust system is hot. Park the motorcycle in a place where pedestrians or children are not likely to touch the motorcycle. Do not park the motorcycle on a slope or soft ground; the motorcycle may overturn.

PERIODIC MAINTENANCE AND MINOR REPAIR

Tool kit	6-1	Inspecting the brake fluid level.....	6-22
Periodic maintenance and lubrication	6-2	Brake fluid replacement.....	6-22
Panel removal and installation.....	6-5	Cable inspection and lubrication.....	6-23
Panel A.....	6-6	Throttle cable and grip lubrication.....	6-23
Panel B.....	6-7	Brake and shift pedal lubrication.....	6-23
Spark plugs	6-7	Brake and clutch lever lubrication	6-24
Engine oil.....	6-9	Sidestand lubrication	6-24
Final gear oil.....	6-11	Front fork inspection	6-25
Air filter	6-12	Steering inspection	6-25
Carburetor adjustment.....	6-13	Wheel bearings.....	6-26
Idle speed adjustment	6-14	Battery	6-26
Throttle cable free play inspection.....	6-15	Fuse replacement.....	6-27
Valve clearance adjustment.....	6-15	Headlight bulb replacement	6-28
Tires	6-15	Turn signal and taillight bulb replacement.....	6-29
Wheels	6-17	Supporting the motorcycle.....	6-30
Clutch lever free play adjustment	6-18	Front wheel removal	6-31
Front brake lever free play adjustment.....	6-19	Front wheel installation	6-31
Rear brake pedal height and free play adjustment.....	6-20	Rear wheel removal.....	6-32
Brake light switch adjustment.....	6-21	Rear wheel installation.....	6-33
Checking the front brake pads and rear brake shoes	6-21	Troubleshooting	6-34
		Troubleshooting chart	6-35

EAU00464

Periodic inspection, adjustment and lubrication will keep your motorcycle in the safest and most efficient condition possible. Safety is an obligation of the motorcycle owner. The maintenance and lubrication schedule chart should be considered strictly as a guide to general maintenance and lubrication intervals. YOU MUST TAKE INTO CONSIDERATION THAT WEATHER, TERRAIN, GEOGRAPHICAL LOCATIONS, AND A VARIETY OF INDIVIDUAL USES ALL TEND TO DEMAND THAT EACH OWNER ALTER THIS TIME SCHEDULE TO SHORTER INTERVALS TO MATCH THE ENVIRONMENT. The most important points of motorcycle inspection, adjustment, and lubrication are explained in the following pages.

EW000060

 WARNING

If you are not familiar with motorcycle service, this work should be done by a Yamaha dealer.

EAU01129

Tool kit

The tool kit is located inside of the storage compartment. (See page 3-11 for compartment opening procedures.) The tools provided in the owner's tool kit are to assist you in the performance of periodic maintenance. However, some other tools such as a torque wrench are also necessary to perform the maintenance correctly.

The service information included in this manual is intended to provide you, the owner, with the necessary information for completing some of your own preventive maintenance and minor repairs.

NOTE:

If you do not have necessary tools required during a service operation, take your motorcycle to a Yamaha dealer for service.

EW000062

 WARNING

Modifications to this motorcycle not approved by Yamaha may cause loss of performance, excessive emissions, and render it unsafe for use. Consult a Yamaha dealer before attempting any changes.

PERIODIC MAINTENANCE AND MINOR REPAIR

EAU00473

PERIODIC MAINTENANCE AND LUBRICATION

NO.	ITEM	CHECKS AND MAINTENANCE JOBS	Initial (1,000 km)	EVERY	
				6,000 km or 6 months (whichever comes first)	12,000 km or 12 months (whichever comes first)
1	* Fuel line	<ul style="list-style-type: none"> • Check fuel hoses for cracks or damage. • Replace if necessary. 		√	√
2	Spark plugs	<ul style="list-style-type: none"> • Check condition. • Clean, regap or replace if necessary. 	√	√	√
3	* Valves	<ul style="list-style-type: none"> • Check valve clearance. • Adjust if necessary. 	√	√	√
4	Air filter	<ul style="list-style-type: none"> • Clean or replace if necessary. 		√	√
5	Clutch	<ul style="list-style-type: none"> • Check operation. • Adjust or replace cable. 	√	√	√
6	* Front brake	<ul style="list-style-type: none"> • Check operation, fluid level and vehicle for fluid leakage. (See NOTE on page 6-4.) • Correct accordingly. • Replace brake pads if necessary. 	√	√	√
7	* Rear brake	<ul style="list-style-type: none"> • Check operation. • Adjust brake pedal and replace brake shoes if necessary. 	√	√	√
8	* Wheels	<ul style="list-style-type: none"> • Check balance, runout, spoke tightness and for damage. • Tighten spokes and rebalance, replace if necessary. 		√	√
9	* Tires	<ul style="list-style-type: none"> • Check tread depth and for damage. • Replace if necessary. • Check air pressure. • Correct if necessary. 		√	√
10	* Wheel bearings	<ul style="list-style-type: none"> • Check bearing for looseness or damage. • Replace if necessary. 		√	√

PERIODIC MAINTENANCE AND MINOR REPAIR

NO.	ITEM	CHECKS AND MAINTENANCE JOBS	Initial (1,000 km)	EVERY	
				6,000 km or 6 months (whichever comes first)	12,000 km or 12 months (whichever comes first)
11	* Swingarm	<ul style="list-style-type: none"> • Check swingarm pivoting point for play. • Correct if necessary. • Lubricate with molybdenum disulfide grease every 24,000 km or 24 months (whichever comes first). 		√	√
12	* Steering bearings	<ul style="list-style-type: none"> • Check bearing play and steering for roughness. • Correct accordingly. • Lubricate with lithium soap base grease every 24,000 km or 24 months (whichever comes first). 		√	√
13	* Chassis fasteners	<ul style="list-style-type: none"> • Make sure that all nuts, bolts and screws are properly tightened. • Tighten if necessary. 		√	√
14	Sidestand	<ul style="list-style-type: none"> • Check operation. • Lubricate and repair if necessary. 		√	√
15	* Sidestand switch	<ul style="list-style-type: none"> • Check operation. • Replace if necessary. 	√	√	√
16	* Front fork	<ul style="list-style-type: none"> • Check operation and for oil leakage. • Correct accordingly. 		√	√
17	* Rear shock absorber assembly	<ul style="list-style-type: none"> • Check operation and shock absorber for oil leakage. • Replace shock absorber assembly if necessary. 		√	√
18	* Carburetors	<ul style="list-style-type: none"> • Check engine idling speed, synchronization and starter operation. • Adjust if necessary. 	√	√	√
19	Engine oil	<ul style="list-style-type: none"> • Check oil level and vehicle for oil leakage. • Correct if necessary. • Change. (Warm engine before draining.) 	√	√	√

PERIODIC MAINTENANCE AND MINOR REPAIR

NO.	ITEM	CHECKS AND MAINTENANCE JOBS	Initial (1,000 km)	EVERY	
				6,000 km or 6 months (whichever comes first)	12,000 km or 12 months (whichever comes first)
20	Engine oil filter element	• Replace.	√		√
21	Final gear oil	• Check oil level and vehicle for oil leakage. • Change oil at initial 1,000 km and thereafter every 24,000 km or 24 months (whichever comes first).	√	√	√

* Since these items require special tools, data and technical skills, they should be serviced by a Yamaha dealer.

EAU02970

NOTE:

- The air filter needs more frequent service if you are riding in unusually wet or dusty areas.
- Hydraulic brake system
 - When disassembling the master cylinder or caliper, always replace the brake fluid. Check the brake fluid level regularly and fill as required.
 - Replace the oil seals on the inner parts of the master cylinder and caliper every two years.
 - Replace the brake hoses every four years or if cracked or damaged.

PERIODIC MAINTENANCE AND MINOR REPAIR

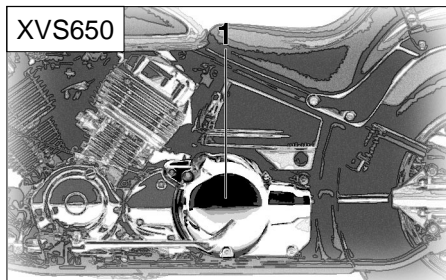

1. Panel A

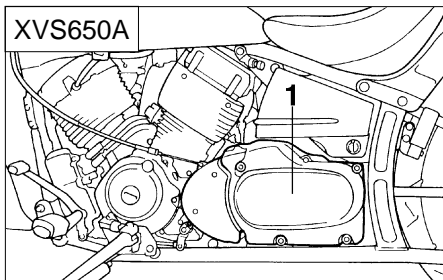

1. Panel A

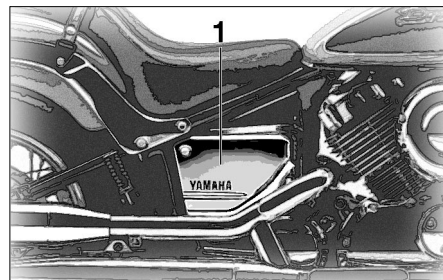

1. Panel B

EAU01122

Panel removal and installation

The panels illustrated need to be removed to perform some of the maintenance described in this chapter. Refer to this section each time a panel has to be removed or reinstalled.

PERIODIC MAINTENANCE AND MINOR REPAIR

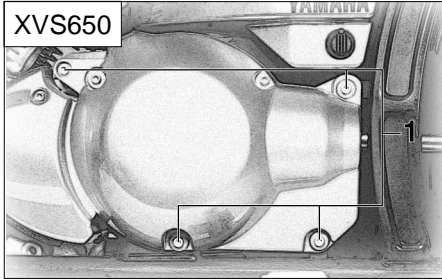

1. Bolt (× 4)

EAU01573

Panel A

To remove

Remove the bolts.

To install

Place the panel in its original position and install the bolts.

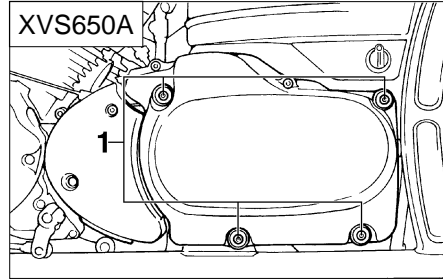

1. Bolt (× 4)

PERIODIC MAINTENANCE AND MINOR REPAIR

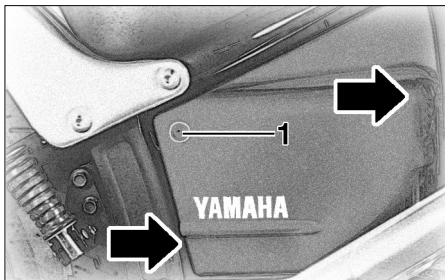

1. Bolt

EAU00491

Panel B

To remove

Remove the bolt and pull outward on the areas shown.

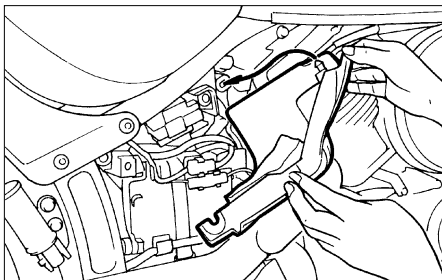

To install

Place the panel in its original position and install the bolt.

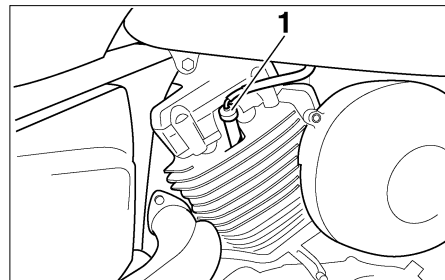

1. Spark plug cap

EAU01485

Spark plugs

Removal

1. Remove the spark plug cap.
2. Use the spark plug wrench in the tool kit to remove the spark plug as shown.

PERIODIC MAINTENANCE AND MINOR REPAIR

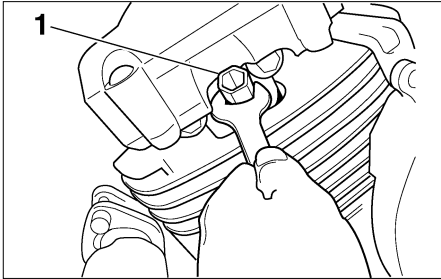

1. Spark plug wrench

Inspection

The spark plug is an important engine component and is easy to inspect. The condition of the spark plug can indicate the condition of the engine. Normally, all spark plugs from the same engine should have the same color on the white insulator around the center electrode. The ideal color at this point is a medium-to-light tan color for a motorcycle that is being ridden normally. If one spark plug shows a distinctly different color, there could be something wrong with the engine. Do not attempt to diagnose such problems yourself. Instead, take the motorcycle to a Yamaha dealer. You should periodically

remove and inspect the spark plugs because heat and deposits will cause any spark plug to slowly break down and erode. If electrode erosion becomes excessive, or if carbon and other deposits are excessive, you should replace the spark plug with the specified plug.

Specified spark plug:

DPR7EA-9 (NGK)

X22EPR-U9 (DENSO)

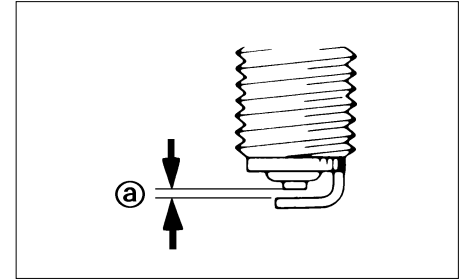

a. Spark plug gap

Installation

1. Measure the electrode gap with a wire thickness gauge and, if necessary, adjust the gap to specification.

Spark plug gap:

0.8 ~ 0.9 mm

2. Clean the gasket surface. Wipe off any grime from the threads.
3. Install the spark plug and tighten it to the specified torque.

PERIODIC MAINTENANCE AND MINOR REPAIR

Tightening torque:
Spark plug:
20 Nm (2.0 m·kg)

NOTE:

If a torque wrench is not available when you are installing a spark plug, a good estimate of the correct torque is 1/4 to 1/2 turn past finger tight. Have the spark plug tightened to the specified torque as soon as possible.

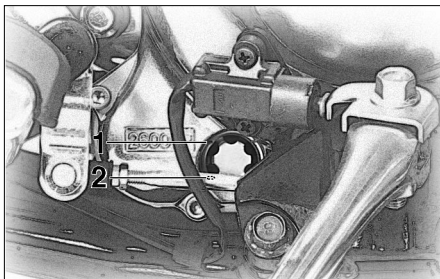

1. Maximum level mark
2. Minimum level mark

EAU01326*

Engine oil Oil level inspection

1. Place the motorcycle on a level place and hold it in an upright position. Warm up the engine for several minutes.

NOTE:

Be sure the motorcycle is positioned straight up when checking the oil level. A slight tilt toward the side can result in false readings.

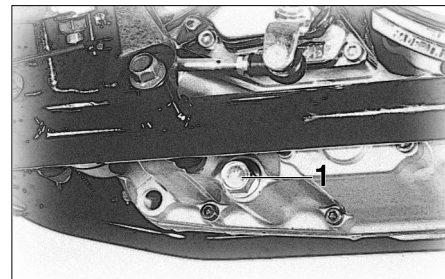

1. Engine oil drain bolt
2. With the engine stopped, check the oil level through the level window located at the lower part of the left side crankcase cover.

NOTE:

Wait a few minutes until the oil level settles before checking.

3. The oil level should be between the maximum and minimum marks. If the level is low, fill the engine with sufficient oil to the specified level.

PERIODIC MAINTENANCE AND MINOR REPAIR

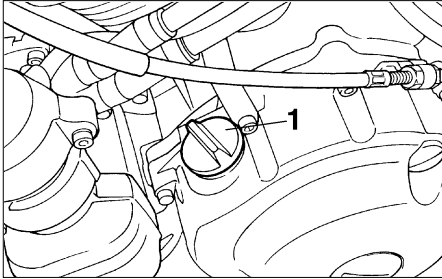

1. Engine oil filler cap

Engine oil and oil filter element replacement

1. Warm up the engine for a few minutes.
2. Stop the engine. Place an oil pan under the engine and remove the oil filler cap.
3. Remove the drain bolt and drain the oil.

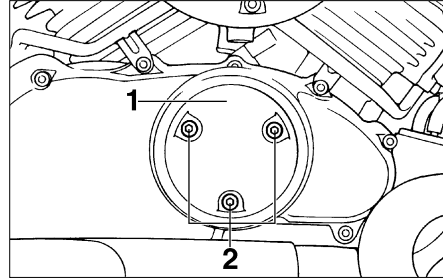

1. Cover
2. Bolt (× 3)

4. Remove the cover and the oil filter cover by removing the bolts.
5. Remove the oil filter and O-ring.
6. Reinstall the drain bolt and tighten it to the specified torque.

Tightening torque:
Drain bolt:
43 Nm (4.3 m·kg)

7. Install a new oil filter and O-ring.

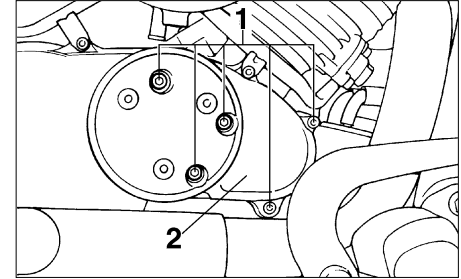

1. Bolt (× 5)
2. Oil filter cover

8. Install oil filter cover and cover, then tighten the bolts.
9. Fill the engine with oil. Install the oil filler cap and tighten it.

Recommended oil:
See page 8-1.

Oil quantity:

Total amount:

3.2 L

Periodic oil change:

2.6 L

With oil filter replacement:

2.8 L

PERIODIC MAINTENANCE AND MINOR REPAIR

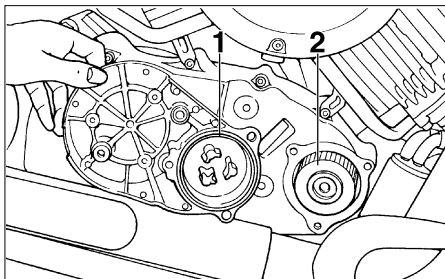

1. O-ring
2. Oil filter element

EC000066

CAUTION:

- Do not put in any chemical additives. Engine oil also lubricates the clutch and additives could cause clutch slippage.
- Be sure no foreign material enters the crankcase.

10. Start the engine and warm it up for a few minutes. While warming up, check for oil leakage. If oil leakage is found, stop the engine immediately and check for the cause.

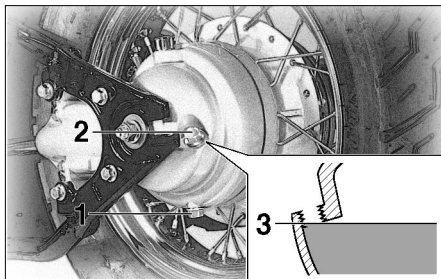

1. Final gear oil drain bolt
2. Final gear oil filler bolt
3. Proper level

EAU02943*

Final gear oil

EW000066

⚠ WARNING

Do not let foreign material enter the final gear case. Be sure oil does not get on the tire or wheel.

Oil level inspection

1. Place the motorcycle on a level place and hold it in an upright position. The engine should be cool at ambient temperature.

2. Remove the oil filler bolt and check the oil level. The oil level should be at the brim of the filler hole. Add the recommended oil if necessary.

Oil replacement

1. Place an oil pan under the final gear case.
2. Remove the oil filler bolt and drain bolt to drain the oil.
3. Install and tighten the drain bolt to the specified torque.

Tightening torque:

Drain bolt:

23 Nm (2.3 m·kg)

4. Fill the gear case to the brim of the filler hole with the recommended oil.

PERIODIC MAINTENANCE AND MINOR REPAIR

Final gear oil quantity:

0.19 L

Recommended oil:

SAE 80 API GL-4 Hypoid gear oil

If desired, an SAE 80W90 hypoid gear oil may be used for all conditions.

NOTE:

“GL-4” is a quality and additive rating. Hypoid gear oils rated “GL-5” or “GL-6” may also be used.

5. Install and tighten the filler bolt to the specified torque.

Tightening torque:

Oil filler bolt:

23 Nm (2.3 m·kg)

6. After replacing the final gear oil, be sure to check for oil leakage.

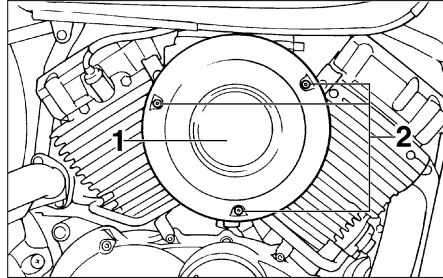

1. Air filter case cover
2. Screw (× 3)

EAU00586*

Air filter

The air filter should be cleaned at the specified intervals. It should be cleaned more frequently if you are riding in unusually wet or dusty areas.

1. Remove the air filter case cover by removing the screws.
2. Remove the air filter.

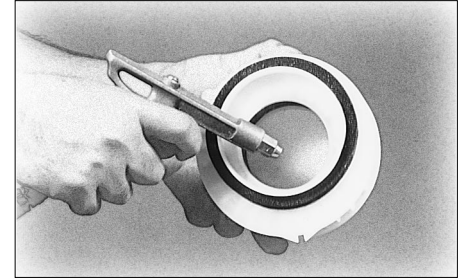

3. Tap the air filter lightly to remove most of the dust and dirt. Blow out the remaining dirt with compressed air as shown. If the air filter is damaged, replace it.

PERIODIC MAINTENANCE AND MINOR REPAIR

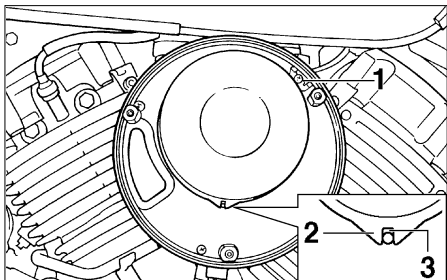

1. Holder
2. Projection
3. Slot

4. Install the air filter into the air filter case as shown.

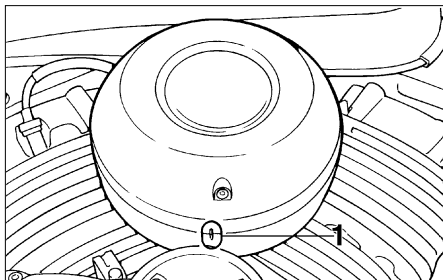

1. Match marks
5. Align the match marks and install the air filter case cover.

EC000082

CAUTION: _____

- Make sure the air filter is properly seated in the air filter case.
- The engine should never be run without the air filter installed. Excessive piston and/or cylinder wear may result.

EAU00630

Carburetor adjustment

The carburetors are important parts of the engine and require very sophisticated adjustment. Most adjustments should be left to a Yamaha dealer who has the professional knowledge and experience to do so. However, the idle speed may be adjusted by the owner as part of routine maintenance.

EC000095

CAUTION: _____

The carburetors were set at the Yamaha factory after many tests. If they are changed, poor engine performance and damage may result.

EAU01168

Idle speed adjustment

NOTE:

A diagnostic tachometer must be used for this procedure.

1. Attach the tachometer. Start the engine and warm it up for a few minutes at approximately 1,000 to 2,000 r/min. Occasionally rev the engine to 4,000 to 5,000 r/min. The engine is warm when it quickly responds to the throttle.

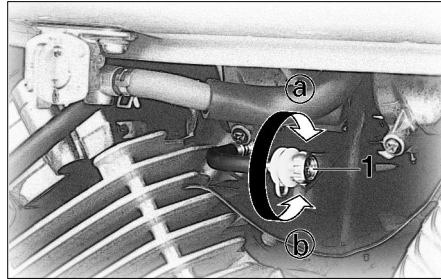

1. Throttle stop screw
2. Set the idle to the specified engine speed by adjusting the throttle stop screw. Turn the screw in direction ① to increase engine speed and in direction ② to decrease engine speed.

Standard idle speed:
1,150 ~ 1,250 r/min

NOTE:

If the specified idle speed cannot be obtained by performing the above adjustment, consult a Yamaha dealer.

PERIODIC MAINTENANCE AND MINOR REPAIR

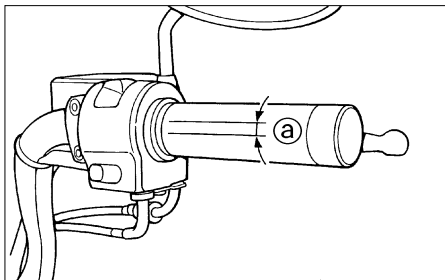

a. Free play

EAU00635

Throttle cable free play inspection

There should be a free play of 4 ~ 6 mm at the throttle grip. If the free play is incorrect, ask a Yamaha dealer to make this adjustment.

6

Valve clearance adjustment

EAU00637

The correct valve clearance changes with use, resulting in improper fuel/air supply or engine noise. To prevent this, the valve clearance must be adjusted regularly. This adjustment however, should be left to a professional Yamaha service technician.

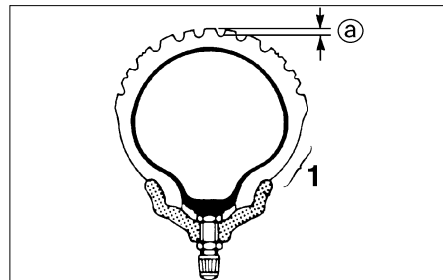

a. Tread depth
1. Side wall

EAU00647*

Tires

To ensure maximum performance, long service, and safe operation, note the following:

Tire air pressure

Always check and adjust the tire pressure before operating the motorcycle.

PERIODIC MAINTENANCE AND MINOR REPAIR

EW000082

WARNING

Tire inflation pressure should be checked and adjusted when the temperature of the tire equals the ambient air temperature. Tire inflation pressure must be adjusted according to total weight of cargo, rider, passenger, and accessories (fairing, saddlebags, etc. if approved for this model), and vehicle speed.

XVS650

Maximum load*	180 kg	
Cold tire pressure	Front	Rear
Up to 90 kg*	200 kPa (2.00 kg/cm ² , 2.00 bar)	225 kPa (2.25 kg/cm ² , 2.25 bar)
90 kg load ~ Maximum load*	200 kPa (2.00 kg/cm ² , 2.00 bar)	250 kPa (2.50 kg/cm ² , 2.50 bar)

* Load is the total weight of cargo, rider, passenger and accessories.

XVS650A

Maximum load*	201 kg (except for D, A) 200 kg (for D, A)	
Cold tire pressure	Front	Rear
Up to 90 kg*	225 kPa (2.25 kg/cm ² , 2.25 bar)	225 kPa (2.25 kg/cm ² , 2.25 bar)
90 kg load ~ Maximum load*	225 kPa (2.25 kg/cm ² , 2.25 bar)	250 kPa (2.50 kg/cm ² , 2.50 bar)

* Load is the total weight of cargo, rider, passenger and accessories.

EW000083

WARNING

Proper loading of your motorcycle is important for several characteristics of your motorcycle, such as handling, braking, performance and safety. Do not carry loosely packed items that can shift. Securely pack your heaviest items close to the center of the motorcycle, and distribute the weight evenly from side to side. Properly adjust the suspension for your load, and check the condition and pressure of your tires. **NEVER OVERLOAD YOUR MOTORCYCLE.** Make sure the total weight of the cargo, rider, passenger, and accessories (fairing, saddlebags, etc. if approved for this model) does not exceed the maximum load of the motorcycle. Operation of an overloaded motorcycle could cause tire damage, an accident, or even injury.

PERIODIC MAINTENANCE AND MINOR REPAIR

EAU00685

Tire inspection

Always check the tires before operating the motorcycle. If center tread depth reaches the limit as shown, if the tire has a nail or glass fragments in it, or if the side wall is cracked, contact a Yamaha dealer immediately and have the tire replaced.

FRONT (XVS650)

Manufacturer	Size	Type
Bridgestone	100/90-19 57S	L309
Dunlop	100/90-19 57S	F24

REAR (XVS650)

Manufacturer	Size	Type
Bridgestone	170/80-15M/C 77S	G546
Dunlop	170/80-15M/C 77S	K555

FRONT (XVS650A)

Manufacturer	Size	Type
Bridgestone	130/90-16 67S	G703
Dunlop	130/90-16 67S	D404F

REAR (XVS650A)

Manufacturer	Size	Type
Bridgestone	170/80-15M/C 77S	G702
Dunlop	170/80-15M/C 77S	D404

Minimum tire tread depth (front and rear)	1.6 mm
--	--------

NOTE:

These limits may be different by regulation from country to country. If so, conform to the limits specified by the regulations of your own country.

EAU00681

WARNING

- **Operating the motorcycle with excessively worn tires decrease riding stability and can lead to loss of control. Have excessively worn tires replaced by a Yamaha dealer immediately. Brakes, tires, and related wheel parts replacement should be left to a Yamaha Service Technician.**
- **Patching a punctured tube is not recommended. If it is absolutely necessary to do so, use great care and replace the tube as soon as possible with a good quality replacement.**

Wheels

To ensure maximum performance, long service, and safe operation, note the following:

- Always inspect the wheels before a ride. Check for cracks, bends or warpage of the wheel. Be sure the spokes are tight and undamaged. If any abnormal condition exists in a wheel, consult a Yamaha dealer. Do not attempt even small repairs to the wheel. If a wheel is deformed or cracked, it must be replaced.
- Tires and wheels should be balanced whenever either one is changed or replaced. Failure to have a wheel balanced can result in poor performance, adverse handling characteristics, and shortened tire life.
- Ride at moderate speeds after changing a tire since the tire surface must first be broken in for it to develop its optimal characteristics.

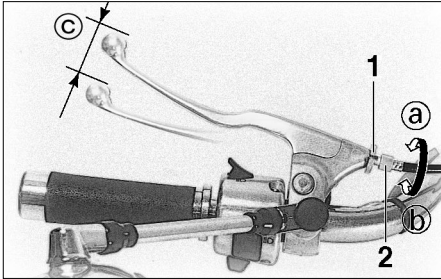

1. Locknut
2. Adjusting bolt
- c. Free play

EAU00694

Clutch lever free play adjustment

The clutch lever free play should be adjusted to 10 ~ 15 mm.

1. Loosen the locknut at the clutch lever.
2. Turn the adjusting bolt at the clutch lever in direction (a) to increase free play or in direction (b) to decrease free play.
3. Tighten the locknut at the clutch lever.

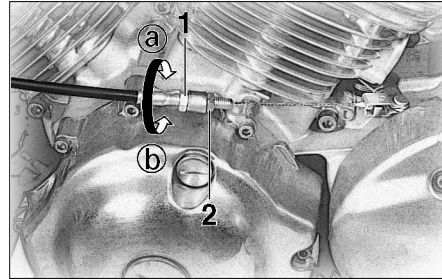

1. Adjusting nut
2. Locknut

If the specified free play cannot be obtained, proceed with the following steps.

4. Loosen the locknut at the clutch lever.
5. Turn the adjusting bolt at the clutch lever in direction (a) to loosen the cable.
6. Loosen the locknut at the crankcase side.
7. Turn the adjusting nut at the crankcase in direction (a) to increase free play or in direction (b) to decrease free play.
8. Tighten the locknut at the crankcase and the clutch lever.

PERIODIC MAINTENANCE AND MINOR REPAIR

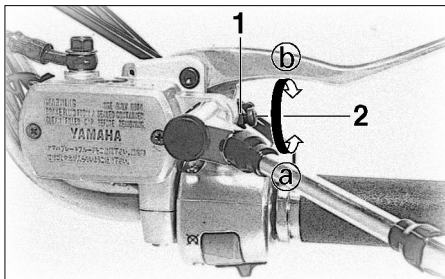

1. Locknut
2. Adjusting bolt

EAU00696

Front brake lever free play adjustment

The free play at the front brake lever should be 10 ~ 15 mm.

1. Loosen the locknut.
2. Turn the adjusting bolt in direction (a) to increase free play or in direction (b) to decrease free play.
3. After adjusting, tighten the locknut.

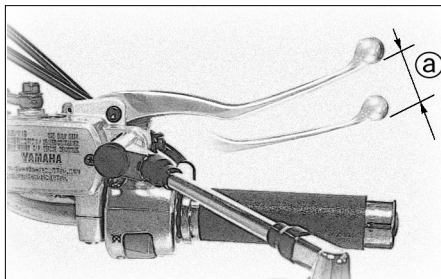

- a. Free play

EW000099

! WARNING

- Check the brake lever free play. Be sure the brake is working properly.
- A soft or spongy feeling in the brake lever can indicate the presence of air in the brake system. This air must be removed by bleeding the brake system before the motorcycle is operated. Air in the system will cause greatly diminished braking capability and can result in loss of control and an

accident. Have a Yamaha dealer inspect and bleed the system if necessary.

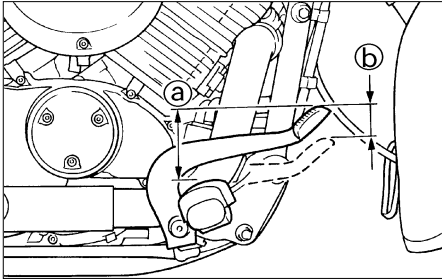

- a. Pedal height
- b. Free play

EAU00711

Rear brake pedal height and free play adjustment

EW000104



It is advisable to have a Yamaha dealer make this adjustment.

The brake pedal height should be adjusted before adjusting the brake pedal free play.

Pedal height

The brake pedal should be positioned approximately 85 mm above the top of the footrest.

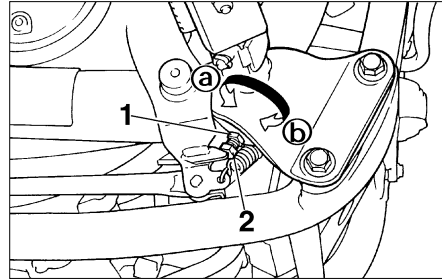

- 1. Locknut
- 2. Adjusting bolt

- a. Loosen the locknut.
- b. Turn the adjusting bolt in direction Ⓐ to raise pedal height or in direction Ⓑ to lower pedal height.
- c. Tighten the locknut.

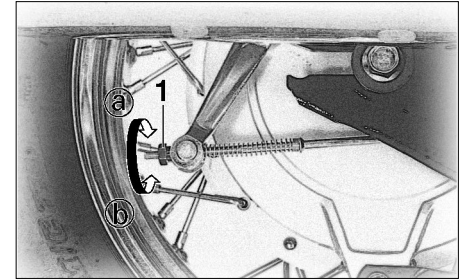

- 1. Adjusting nut

EW000105



After adjusting the pedal height adjust brake pedal free play.

Free play

The brake pedal free play should be adjusted to 20 ~ 30 mm at the brake pedal end. Turn the adjusting nut on the brake rod in direction Ⓐ to increase free play or in direction Ⓑ to decrease free play.

PERIODIC MAINTENANCE AND MINOR REPAIR

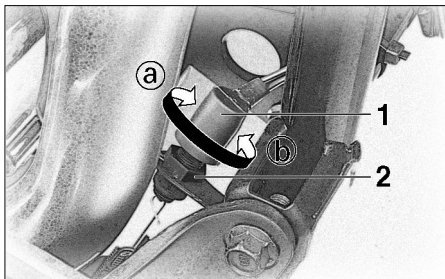

1. Brake light switch
2. Adjusting nut

EAU00713

Brake light switch adjustment

The rear brake light switch is activated by the brake pedal and is properly adjusted when the brake light comes on just before braking takes effect. To adjust the rear brake light switch, hold the switch body so it does not rotate while turning the adjusting nut. Turn the adjusting nut in direction **a** to make the brake light come on earlier. Turn the adjusting nut in direction **b** to make the brake light come on later.

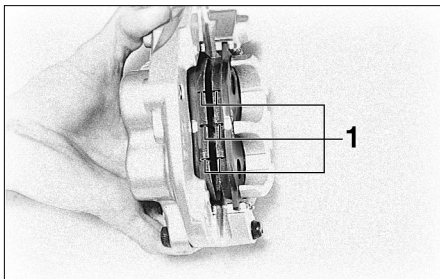

1. Wear indicator grooves

EAU00720

Checking the front brake pads and rear brake shoes

EAU01119

Front brake

Wear indicator grooves are provided on each brake pad. These indicators allow checking of brake pad wear without disassembling the brake. Inspect the grooves. If they have almost disappeared, ask a Yamaha dealer to replace the pads.

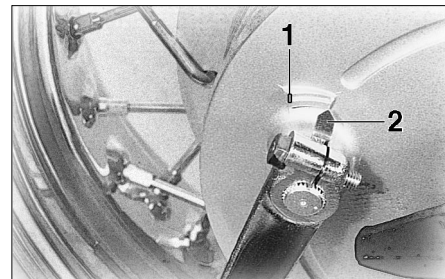

1. Wear limit line
2. Wear indicator

EAU00727

Rear brake

Apply the brake and inspect the wear indicator.

If the indicator reaches the wear limit line, ask a Yamaha dealer to replace the shoes.

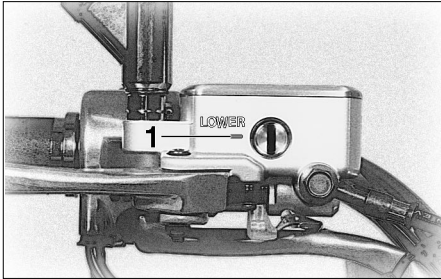

1. Minimum level mark

EAU00731

Inspecting the brake fluid level

Insufficient brake fluid may let air enter the brake system, possibly causing the brakes to become ineffective.

Before riding, check that the brake fluid is above the minimum level and replenish when necessary. Observe these precautions:

- When checking the fluid level, make sure the top of the master cylinder is level by turning the handlebars.

- Use only the designated quality brake fluid. Otherwise, the rubber seals may deteriorate, causing leakage and poor brake performance.

Recommended brake fluid: DOT 4

- Refill with the same type of brake fluid. Mixing fluids may result in a harmful chemical reaction and lead to poor brake performance.
- Be careful that water does not enter the master cylinder when refilling. Water will significantly lower the boiling point of the fluid and may result in vapor lock.
- Brake fluid may deteriorate painted surfaces or plastic parts. Always clean up spilled fluid immediately.
- Have a Yamaha dealer check the cause if the brake fluid level goes down.

Brake fluid replacement

The brake fluid should be replaced only by trained Yamaha service personnel. Have the Yamaha dealer replace the following components during periodic maintenance or when they are damaged or leaking:

- oil seals (every two years)
- brake hoses (every four years)

PERIODIC MAINTENANCE AND MINOR REPAIR

Cable inspection and lubrication

EAU02962

⚠ WARNING

Damage to the outer housing of cables may lead to internal rusting and interfere with the cable movement. Replace damaged cables as soon as possible to prevent unsafe conditions.

EW000112

Lubricate the cables and cable ends. If a cable does not operate smoothly, ask a Yamaha dealer to replace it.

Recommended lubricant:
Engine oil

Throttle cable and grip lubrication

EAU00773

The throttle twist grip assembly should be greased at the time that the cable is lubricated, since the grip must be removed to get at the end of the throttle cable. After removing the screws, hold the end of the cable up in the air and put in several drops of lubricant. With the throttle grip disassembled, coat the metal surface of the grip assembly with a suitable all-purpose grease.

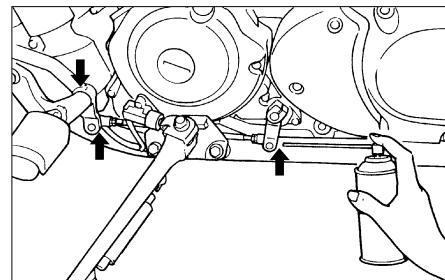

EAU02984

Brake and shift pedal lubrication

Lubricate the pivoting parts.

Recommended lubricant:
Engine oil

PERIODIC MAINTENANCE AND MINOR REPAIR

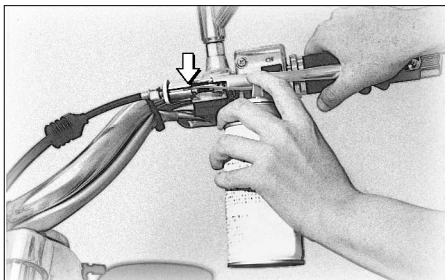

EAU02985

Brake and clutch lever lubrication

Lubricate the pivoting parts.

Recommended lubricant:
Engine oil

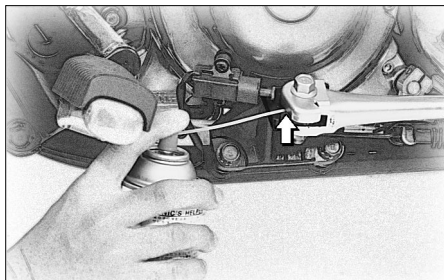

EAU02986

Sidestand lubrication

Lubricate the sidestand pivoting point and metal-to-metal contact surfaces. Check that the sidestand moves up and down smoothly.

Recommended lubricant:
Engine oil

EW000113

⚠ WARNING

If the sidestand does not move smoothly, consult a Yamaha dealer.

PERIODIC MAINTENANCE AND MINOR REPAIR

Front fork inspection

Visual check

EAU02939

EW000115

⚠ WARNING

Securely support the motorcycle so there is no danger of it falling over.

Check for scratches or damage on the inner tube and excessive oil leakage from the front fork.

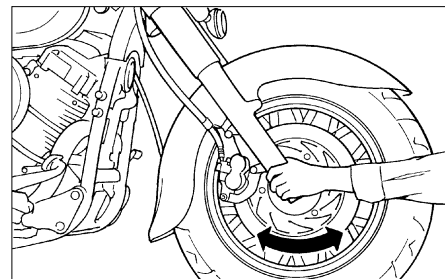
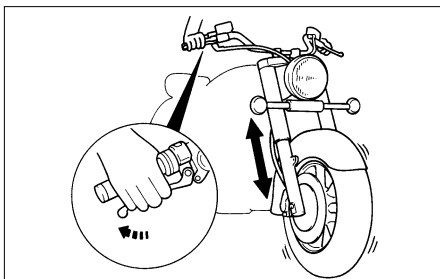

EAU00794

Operation check

1. Place the motorcycle on a level place.
2. Hold the motorcycle in an upright position and apply the front brake.
3. Push down hard on the handlebars several times and check if the fork rebounds smoothly.

EC000098

CAUTION:

If any damage or unsmooth movement is found with the front fork, consult a Yamaha dealer.

Steering inspection

Periodically inspect the condition of the steering. Worn out or loose steering bearings may be dangerous. Place a stand under the engine to raise the front wheel off the ground. Hold the lower end of the front forks and try to move them forward and backward. If any free play can be felt, ask a Yamaha dealer to inspect and adjust the steering. Inspection is easier if the front wheel is removed.

EW000115

⚠ WARNING

Securely support the motorcycle so there is no danger of it falling over.

PERIODIC MAINTENANCE AND MINOR REPAIR

EAU01144

Wheel bearings

If there is play in the front or rear wheel hub or if the wheel does not turn smoothly, have a Yamaha dealer inspect the wheel bearings.

EAU00800

Battery

This motorcycle is equipped with a sealed-type battery. Therefore it is not necessary to check the electrolyte or fill the battery with distilled water.

- If the battery seems to have discharged, consult a Yamaha dealer.
- If the motorcycle is equipped with optional electrical accessories, the battery tends to discharge more quickly, so be sure to recharge it periodically.

EC000101

CAUTION:

Never try to remove the sealing caps of the battery cells. The battery will be damaged.

EW000116

WARNING

Battery electrolyte is poisonous and dangerous, causing severe burns, etc. It contains sulfuric acid. Avoid contact with skin, eyes or clothing.

ANTIDOTE:

- **EXTERNAL:** Flush with water.
- **INTERNAL:** Drink large quantities of water or milk. Follow with milk of magnesia, beaten egg, or vegetable oil. Call a physician immediately.
- **EYES:** Flush with water for 15 minutes and get prompt medical attention.

Batteries produce explosive gases. Keep sparks, flame, cigarettes etc., away. Ventilate when charging or using in an enclosed space. Always shield your eyes when working near batteries. KEEP OUT OF REACH OF CHILDREN.

PERIODIC MAINTENANCE AND MINOR REPAIR

Battery storage

When the motorcycle is not used for a month or longer, remove the battery, fully charge it and store it in a cool, dry place.

EC000102

CAUTION:

- Completely recharge the battery before storing. Storing a discharged battery can cause permanent battery damage.
- Use a battery charger designed for a sealed-type (MF) battery. Using a conventional battery charger will cause battery damage. If you do not have a sealed-type battery charger, contact your Yamaha dealer.
- Always make sure the connections are correct when reinstalling the battery.

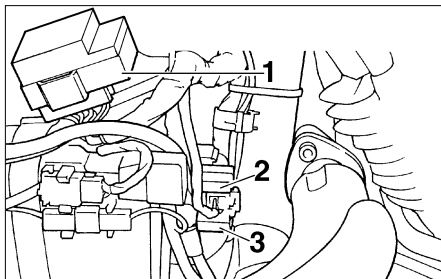

1. Fuse block
2. Main fuse
3. Spare fuse

EAU00825*

Fuse replacement

The fuses are located behind panel B. (See page 6-5 for panel removal procedures.)

If a fuse is blown, turn off the main switch and the switch of the circuit in question. Install a new fuse of proper amperage. Turn on the switches and see if the electrical device operates. If the fuse immediately blows again, consult a Yamaha dealer.

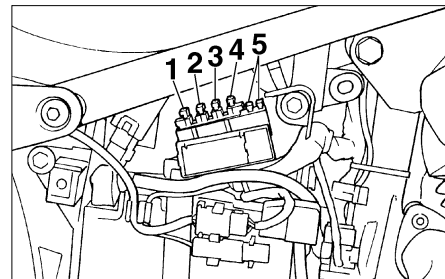

1. Ignition fuse
2. Signaling system fuse
3. Headlight fuse
4. Carburetor heater fuse
5. Spare fuse

EC000103

CAUTION:

Do not use fuses of higher amperage rating than those recommended. Substitution of a fuse of improper rating can cause extensive electrical system damage and possibly a fire.

PERIODIC MAINTENANCE AND MINOR REPAIR

Specified fuses:

Main fuse:	30 A
Ignition fuse:	10 A
Signaling system fuse:	10 A
Headlight fuse:	15 A
Carburetor heater fuse:	15 A

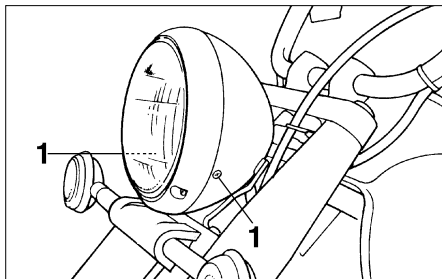

1. Screw (× 2)

EAU00833

Headlight bulb replacement

This motorcycle is equipped with a quartz bulb headlight.

If the headlight bulb burns out, replace the bulb as follows:

1. Remove the headlight unit screws.
2. Remove the connectors, the headlight unit and then the bulb cover.

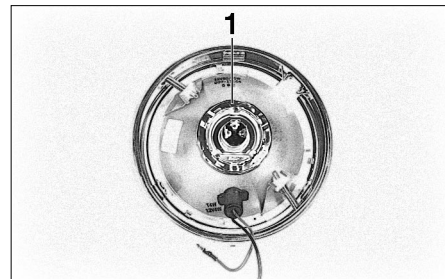

1. Bulb holder

3. Turn the bulb holder counter-clockwise to remove it and remove the defective bulb.

EW000119

WARNING

Keep flammable products and your hands away from a bulb while it is on, as it is hot. Do not touch a bulb until it cools down.

4. Put a new bulb into position and secure it in place with the bulb holder.

PERIODIC MAINTENANCE AND MINOR REPAIR

EC000105

CAUTION:

Avoid touching the glass part of a bulb. Keep it free from oil; otherwise, the transparency of the glass, life of the bulb, and luminous flux will be adversely affected. If oil gets on a bulb, thoroughly clean it with a cloth moistened with alcohol or lacquer thinner.

5. Install the bulb cover, connectors and headlight unit. Ask a Yamaha dealer to adjust the headlight beam if necessary.

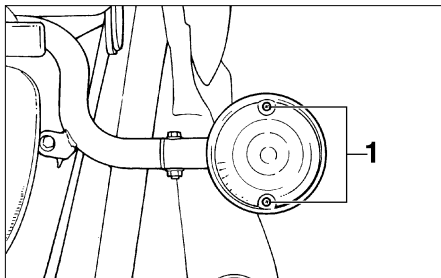

1. Screw (× 2)

EAU00855

Turn signal and taillight bulb replacement

1. Remove the screws and the lens.
2. Push the bulb inward and turn it counterclockwise.

XVS650

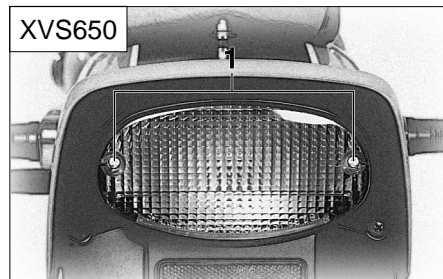

1. Screw (× 2)

3. Place a new bulb in the socket. Push the bulb inward and turn it clockwise until it engages into the socket.
4. Install the lens and the screws.

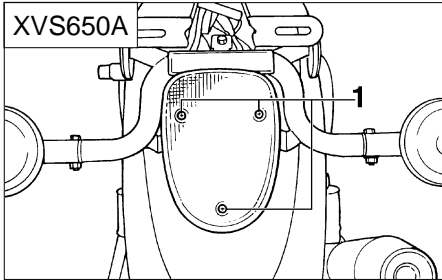

1. Screw (× 3)

EC000108

CAUTION:

Do not over-tighten the screws as the lens may break.

EAU01579

Supporting the motorcycle

Since the Yamaha XVS650/XVS650A has no centerstand, follow these precautions when removing the front and rear wheel or performing other maintenance requiring the motorcycle to stand upright. Check that the motorcycle is in a stable and level position before starting any maintenance. A strong wooden box can be placed under the engine for added stability.

Front wheel service

To stabilize the rear of the motorcycle, either use a motorcycle stand or place a motorcycle jack under the frame in front of the rear wheel to prevent it from moving from side to side. Then use a motorcycle stand to elevate the front wheel off of the ground.

Rear wheel service

Use a motorcycle stand or motorcycle jack to elevate the motorcycle so the rear wheel is off the ground. Alternatively, two jacks can be placed under the frame or swingarm.

PERIODIC MAINTENANCE AND MINOR REPAIR

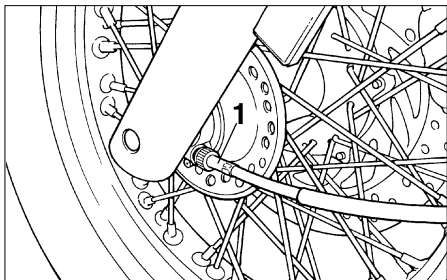

1. Speedometer cable

EAU00894

Front wheel removal

EW000122

⚠ WARNING

- It is advisable to have a Yamaha dealer service the wheel.
- Securely support the motorcycle so there is no danger of it falling over.

1. Remove the speedometer cable from the front wheel side.

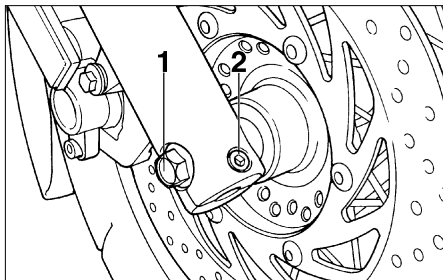

1. Axle
2. Pinch bolt

2. Loosen the pinch bolt and wheel axle.
3. Elevate the front wheel by placing a suitable stand under the engine.
4. Remove the wheel axle and the front wheel.

NOTE:

Do not depress the brake lever when the disc and caliper are separated.

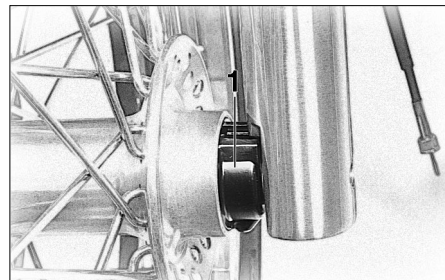

1. Speedometer gear unit housing

EAU01394

Front wheel installation

1. Install the speedometer gear unit into the wheel hub. Make sure the wheel hub and the speedometer gear unit are installed with the projections meshed into the slots.
2. Lift up the wheel between the front fork legs and guide the brake disc between the brake pads. Make sure the slot in the speedometer gear unit fits over the stopper on the front fork outer tube.
3. Install the wheel axle and let the motorcycle down.

PERIODIC MAINTENANCE AND MINOR REPAIR

4. Push down hard on the handlebars several times to check for proper fork operation.
5. Tighten the wheel axle to the specified torque.
6. Install the pinch bolt and tighten it to the specified torque.

Tightening torque:

Wheel axle:

59 Nm (5.9 m·kg)

Pinch bolt:

20 Nm (2.0 m·kg)

7. Install the speedometer cable.

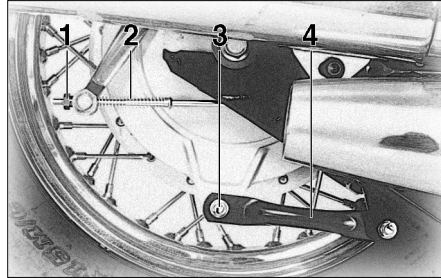

1. Adjusting nut
2. Brake rod
3. Brake torque rod bolt (× 2)
4. Brake torque rod

EAU01350*

Rear wheel removal

EW000122

⚠ WARNING

- It is advisable to have a Yamaha dealer service the wheel.
- Securely support the motorcycle so there is no danger of it falling over.

1. Loosen the axle nut. Do not remove it.
2. Remove the brake torque rod bolt on the brake shoe plate side.
3. Loosen the brake torque rod bolt on the swingarm side.
4. Remove the brake pedal free play adjusting nut and then the brake rod from the brake cam lever.
5. Remove panel A. (See page 6-5 for removal procedures.)

PERIODIC MAINTENANCE AND MINOR REPAIR

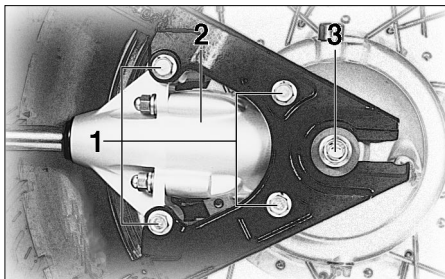

1. Bolt (× 4)
2. Final gear case
3. Axle nut

6. Remove the bolts that secure the final gear case to the swingarm.
7. Elevate the rear wheel off of the ground.
8. Pull the wheel backward while supporting the drive shaft to remove the wheel, axle, final gear case and drive shaft as an assembly.

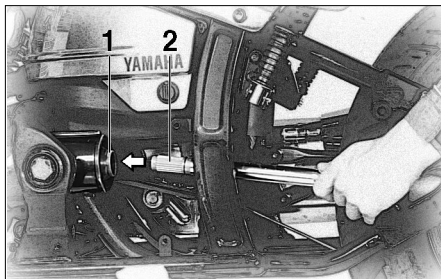

1. Middle drive shaft joint
2. Drive shaft

EAU01563

Rear wheel installation

1. Install the rear wheel, axle, final gear case and drive shaft as an assembly by pushing the wheel forward and guiding the drive shaft into the middle drive shaft U-joint.
2. Install the bolts that secure the final gear case to the swingarm and tighten to the specified tightening torque.

Specified torque:
Final gear case bolts:
90 Nm (9.0 m·kg)

3. Insert the brake rod into the brake cam lever and install the brake pedal free play adjusting nut.
4. Install the brake torque rod bolt and tighten both bolts to the specified tightening torque.

Specified torque:
Brake torque rod bolts:
20 Nm (2.0 m·kg)

5. Install panel A.
6. Let the motorcycle down.
7. Tighten the axle nut to the specified tightening torque.

Specified torque:
Axle nut:
92 Nm (9.2 m·kg)

8. Adjust the rear brake pedal free play. (See page 6-20.)

EAU01008

Troubleshooting

Although Yamaha motorcycles receive a rigid inspection before shipment from the factory, trouble may occur during operation.

Any problem in the fuel, compression, or ignition systems can cause poor starting and loss of power. The troubleshooting chart describes a quick, easy procedure for making checks.

If your motorcycle requires any repair, bring it to a Yamaha dealer. The skilled technicians at a Yamaha dealership have the tools, experience, and know-how to properly service your motorcycle. Use only genuine Yamaha parts on your motorcycle. Imitation parts may look like Yamaha parts, but they are often inferior. Consequently, they have a shorter service life and can lead to expensive repair bills.

PERIODIC MAINTENANCE AND MINOR REPAIR

Troubleshooting chart

EAU01297*

EW000125



Never check the fuel system while smoking or in the vicinity of an open flame.

1. Fuel

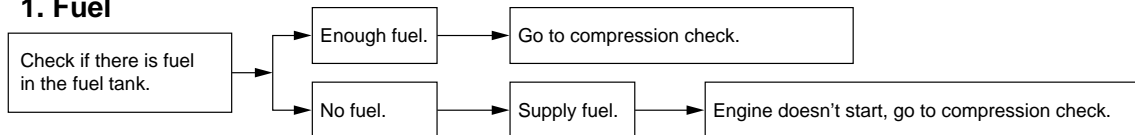

2. Compression

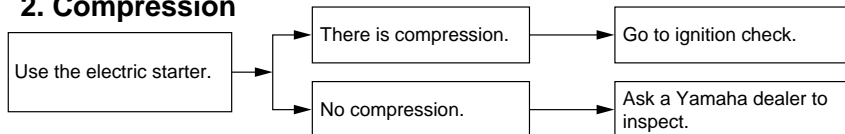

3. Ignition

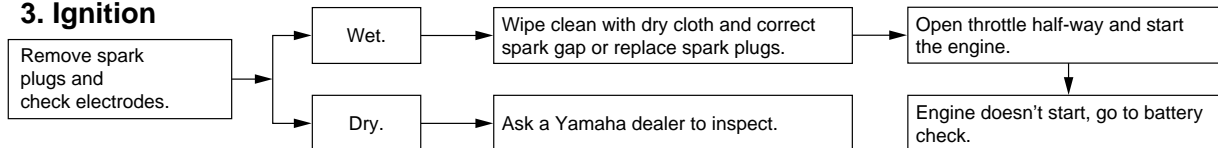

4. Battery

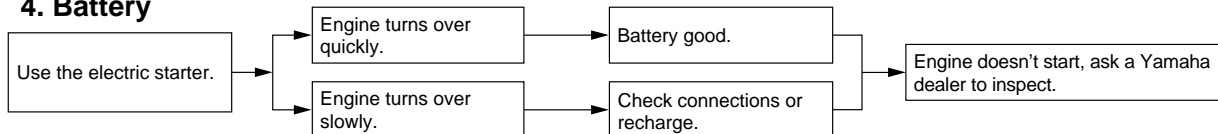

MOTORCYCLE CARE AND STORAGE

Care	7-1
Storage	7-4

Care

The exposure of its technology makes a motorcycle charming but also vulnerable. Although high-quality components are used, they are not all rust-resistant. While a rusty exhaust pipe may remain unnoticed on a car, it does look unattractive on a motorcycle. Frequent and proper care, however, will keep your motorcycle looking good, extend its life and maintain its performance. Moreover, the warranty states that the vehicle must be properly taken care of. For all these reasons, it is recommended that you observe the following cleaning and storing precautions.

Before cleaning

1. Cover up the muffler outlets with plastic bags.
2. Make sure that all caps and covers as well as all electrical couplers and connectors, including the spark plug caps, are tightly installed.
3. Remove extremely stubborn dirt, like oil burnt onto the crankcase, with a degreasing agent and a brush, but never apply such products onto seals, gaskets and wheel axles. Always rinse the dirt and degreaser off with water.

Cleaning

After normal use

Remove dirt with warm water, a neutral detergent and a soft clean sponge, then rinse with plenty of clean water. Use a tooth or bottle brush for hard-to-reach parts. Tougher dirt and insects will come off more easily if the area is covered with a wet cloth for a few minutes before cleaning.

MOTORCYCLE CARE AND STORAGE

ECA00010

CAUTION:

- Avoid using strong acidic wheel cleaners, especially on spoked wheels. If you do use such products for hard-to-remove dirt, do not leave it on any longer than instructed, then thoroughly rinse it off with water, immediately dry the area and apply a corrosion protection spray.
 - Improper cleaning can damage windshields, cowlings, panels and other plastic parts. Use only a soft, clean cloth or sponge with mild detergent and water to clean plastic.
 - Do not use any harsh chemical products on plastic parts. Be sure to avoid using cloths or sponges which have been in contact with strong or abrasive cleaning products, solvent or thinner, fuel (gasoline), rust removers or inhibitors, brake fluid, antifreeze or electrolyte.
 - Do not use high-pressure washers or steam-jet cleaners since they cause water seepage and deterioration in the following areas: seals (of wheel bearings, swingarm bearings, forks and brakes), electric components (couplers, connectors, instruments, switches and lights), breather hoses and vents.
 - For motorcycles equipped with a windshield: Do not use strong cleaners or hard sponges as they will cause dulling or scratching. Some cleaning compounds for plastic may leave scratches on the windshield. Test the product on a small hidden part of the windshield to make sure they do not leave any marks. If the windshield is scratched, use a quality plastic polishing compound after washing.
-

After riding in the rain, near the sea or on salt-sprayed roads

Since sea salt or salt sprayed on the roads in the winter are extremely corrosive in combination with water, carry out the following steps after each ride in the rain, near the sea or on salt-sprayed roads. (Salt sprayed in the winter may remain on the roads well into spring.)

MOTORCYCLE CARE AND STORAGE

EWA00001

1. Clean your motorcycle with cold water and soap after the engine has cooled down.

ECA00012

CAUTION:

Do not use warm water since it increases the corrosive action of the salt.

2. Be sure to apply a corrosion protection spray on all (even chrome and nickel-plated) metal surfaces to prevent corrosion.

After cleaning

1. Dry the motorcycle with a cham-
ois or an absorbing cloth.
2. Use a chrome polish to shine
chrome, aluminum and stainless-
steel parts, including the exhaust
system. (Even the thermally in-
duced discoloring of stainless-
steel exhaust systems can be re-
moved through polishing.)
3. To prevent corrosion, it is recom-
mended to apply a corrosion pro-
tection spray on all (even chrome-
and nickel-plated) metal surfaces.
4. Use spray oil as a universal clean-
er to remove any remaining dirt.
5. Touch up minor paint damage
caused by stones, etc.
6. Wax all painted surfaces.
7. Let the motorcycle dry completely
before storing it or covering it.

WARNING

Make sure that there is no oil or wax on the brakes and tires. If necessary, clean the brake discs and linings with a regular brake disc cleaner or acetone, and wash the tires with warm water and mild soap. Then, carefully test the motorcycle for its braking performance and cornering behavior.

ECA00013

CAUTION:

- **Apply spray oil and wax sparingly and wipe off any excess.**
- **Never apply oil or wax on rubber and plastic parts, but treat them with a suitable care product.**
- **Avoid using abrasive polishing compounds as they wear away the paint.**

NOTE:

Consult a Yamaha dealer for advice on what products to use.

Storage

Short-term

Always store your motorcycle in a cool, dry place and, if necessary, protect it against dust with a porous cover.

ECA00014

CAUTION:

- **Storing the motorcycle in a poorly ventilated room or covering it with a tarp while it is still wet will allow water and humidity to seep in and cause rust.**
 - **To prevent corrosion, avoid damp cellars, stables (because of the presence of ammonia) and areas where strong chemicals are stored.**
-

Long-term

Before storing your motorcycle for several months:

1. Follow all the instructions in the “Care” section of this chapter.
2. Drain the carburetor float chambers by loosening the drain bolts; this will prevent fuel deposits from building up. Pour the drained fuel into the fuel tank.
3. Only for motorcycles equipped with a fuel cock which has an “OFF” position: Turn the fuel cock to “OFF”.
4. Fill up the fuel tank and add fuel stabilizer (if available) to prevent the fuel tank from rusting and the fuel from deteriorating.
5. Perform the following steps to protect the cylinders, piston rings, etc. from corrosion.
 - a. Remove the spark plug caps and spark plugs.
 - b. Pour a teaspoonful of engine oil into each spark plug bore.

- d. Install the spark plug caps onto the spark plugs and place the spark plugs on the cylinder head so that the electrodes are grounded. (This will limit sparking during the next step.)
- e. Turn the engine over several times with the starter. (This will coat the cylinder walls with oil.)
- e. Remove the spark plug caps from the spark plugs, install the spark plugs and then the spark plug caps.

EWA00003

WARNING

When turning the engine over, be sure to ground the spark plug electrodes to prevent damage or injury from sparking.

6. Lubricate all control cables and the pivoting points of all levers and pedals as well as of the side-stand/centerstand.

MOTORCYCLE CARE AND STORAGE

7. Check and, if necessary, correct the tire air pressure, then raise the motorcycle so that both of its wheels are off the ground. Alternatively, turn the wheels a little every month in order to prevent the tires from becoming degraded in one spot.
8. Cover up the muffler outlets with plastic bags to prevent moisture from entering.
9. Remove the battery and fully charge it. Store it in a cool, dry place and recharge it once a month. Do not store the battery in an excessively cold or warm place (less than 0°C or more than 30°C). For more information, see “Battery storage” in the chapter “PERIODIC MAINTENANCE AND MINOR REPAIRS”.

NOTE: _____

Make any necessary repairs before storing the motorcycle.

Specifications 8-1
HOW TO USE THE CONVERSION TABLE 8-6

Specifications

Model	XVS650/XVS650A	
Dimensions		
XVS650		
Overall length	2,340 mm	
Overall width	880 mm	
Overall height	1,065 mm	
Seat height	695 mm	
Wheelbase	1,610 mm	
Ground clearance	140 mm	
Minimum turning radius	3,100 mm	
XVS650A		
Overall length	2,450 mm	
Overall width	930 mm	
Overall height	1,105 mm	
Seat height	710 mm	
Wheelbase	1,625 mm	
Ground clearance	145 mm	
Minimum turning radius	3,400 mm	
Basic weight (with oil and full fuel tank)		
XVS650	227 kg	
XVS650A	242 kg	(except for D, A)
	243 kg	(for D, A)

Engine

Engine type	Air-cooled 4-stroke, SOHC
Cylinder arrangement	V type 2-cylinder
Displacement	649 cm ³
Bore × stroke	81 × 63 mm
Compression ratio	9:1
Starting system	Electric starter
Lubrication system	Wet sump

Engine oil

Type

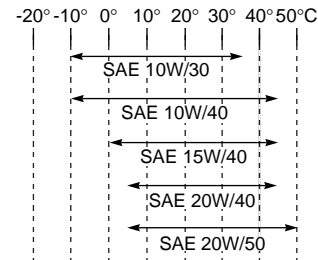

Recommended engine oil classification

API Service SE, SF, SG type or higher

CAUTION:

Be sure to use motor oils that do not contain anti-friction modifiers. Passenger car motor oils (often labeled "Energy Conserving") contain anti-friction additives which will cause clutch and/or starter clutch slippage, resulting in reduced component life and poor engine performance.

Quantity

Periodic oil change	2.6 L
With oil filter replacement	2.8 L
Total amount	3.2 L

Final gear oil

Type	SAE80API "GL-4" Hypoid Gear Oil
Quantity	0.19 L

Air filter

Dry type element

Fuel

Type	Regular unleaded gasoline
Fuel tank capacity	16 L
Reserve amount	3 L

Carburetor

Type × quantity	BDS28 × 2
Manufacturer	MIKUNI

Spark plug

Type/Manufacturer	DPR7EA-9 / NGK X22EPR-U9 / DENSO
Gap	0.8 ~ 0.9 mm

Clutch type

Wet, multiple-disc

Transmission

Primary reduction system	Spur gear
Primary reduction ratio	1.789
Secondary reduction system	Shaft drive
Secondary reduction ratio	3.071
Transmission type	Constant mesh 5-speed
Operation	Left foot operation
Gear ratio	1st 2.714 2nd 1.900 3rd 1.458 4th 1.166 5th 0.966

Chassis

XVS650

Frame type	Double cradle
Caster angle	35°
Trail	153 mm

SPECIFICATIONS

XVS650A

Frame type	Double cradle
Caster angle	35°
Trail	145 mm

Tires

XVS650

Type	Tube
Front	
Size	100/90-19 57S
Manufacturer/ model	Bridgestone / L309 Dunlop / F24
Rear	
Size	170/80-15 M/C 77S
Manufacturer/ model	Bridgestone / G546 Dunlop / K555
Maximum load	180 kg
Air pressure (cold tire)	
Up to 90 kg load*	
Front	200 kPa; 2.00 kg/cm ² ; 2.00 bar
Rear	225 kPa; 2.25 kg/cm ² ; 2.25 bar
90 kg load ~ Maximum load*	
Front	200 kPa; 2.00 kg/cm ² ; 2.00 bar
Rear	250 kPa; 2.50 kg/cm ² ; 2.50 bar

XVS650A

Type	Tube
Front	
Size	130/90-16 67S
Manufacturer/ model	Bridgestone / G703 Dunlop / D404F
Rear	
Size	170/80-15 M/C 77S
Manufacturer/ model	Bridgestone / G702 Dunlop / D404
Maximum load	201 kg (except for D, A) 200 kg (for D, A)
Air pressure (cold tire)	
Up to 90 kg load*	
Front	225 kPa; 2.25 kg/cm ² ; 2.25 bar
Rear	225 kPa; 2.25 kg/cm ² ; 2.25 bar
90 kg load ~ Maximum load*	
Front	225 kPa; 2.25 kg/cm ² ; 2.25 bar
Rear	250 kPa; 2.50 kg/cm ² ; 2.50 bar

* Load is total weight of cargo, rider, passenger and accessories.

Wheels

XVS650

Front

Type	Spoke
Size	19 × MT2.50

Rear

Type	Spoke
Size	15M/C × MT3.50

XVS650A

Front

Type	Spoke
Size	16 × MT3.00

Rear

Type	Spoke
Size	15M/C × MT3.50

Brakes

Front

Type	Single disc brake
Operation	Right hand operation
Fluid	DOT 4

Rear

Type	Drum brake
Operation	Right foot operation

Suspension

Front

Type	Telescopic fork
------	-----------------

Rear

Type	Swingarm
------	----------

Shock absorber

Front

Coil spring/oil damper

Rear

Coil spring/gas-oil damper, spring preload adjustable

Wheel travel

XVS650

Front

140 mm

Rear

86 mm

XVS650A

Front

140 mm

Rear

98 mm

Electrical

Ignition system

T.C.I. (digital)

Charging system

Type

A.C. magneto

Standard output

14 V 20 A @ 5,000 rpm

Battery

Type

GT12B-4

Voltage, capacity

12 V, 10 AH

SPECIFICATIONS

Headlight type	Quartz bulb (halogen)
Bulb voltage, wattage × quantity	
XVS650	
Headlight	12 V, 60/55 W × 1
Auxiliary light	12 V, 4 W × 1 (except for GB) 12 V, 3.4 W × 1 (for GB)
Tail/brake light	12 V, 5/21 W
Turn signal light	12 V, 21 W × 4
Meter light	12 V, 1.7 W × 1
Neutral indicator light	12 V, 1.7 W × 1
High beam indicator light	12 V, 1.7 W × 1
Turn indicator light	12 V, 1.7 W × 1
Engine trouble indicator light	12 V, 1.7 W × 1
XVS650A	
Headlight	12 V, 60/55 W × 1
Auxiliary light	12 V, 4 W × 1
Tail/brake light	12 V, 5/21 W
Turn signal light	12 V, 21 W × 4
Meter light	12 V, 1.7 W × 1
Neutral indicator light	12 V, 1.7 W × 1
High beam indicator light	12 V, 1.7 W × 1
Turn indicator light	12 V, 1.7 W × 1
Engine trouble indicator light	12 V, 1.7 W × 1

Fuses	
Main fuse	30 A
Ignition fuse	10 A
Signaling system fuse	10 A
Headlight fuse	15 A
Carburetor heater fuse	15 A

EAU01064

HOW TO USE THE CONVERSION TABLE

All specification data in this manual are listed in SI and METRIC UNITS.

Use this table to convert METRIC unit data to IMPERIAL unit data.

Ex.

METRIC		MULTIPLIER		IMPERIAL
**mm	×	0.03937	=	**in
2 mm	×	0.03937	=	0.08 in

CONVERSION TABLE

METRIC TO IMPERIAL			
	Metric unit	Multiplier	Imperial unit
Torque	m·kg	7.233	ft·lb
	m·kg	86.794	in·lb
	cm·kg	0.0723	ft·lb
	cm·kg	0.8679	in·lb
Weight	kg	2.205	lb
	g	0.03527	oz
Speed	km/hr	0.6214	mph
Distance	km	0.6214	mi
	m	3.281	ft
	m	1.094	yd
	cm	0.3937	in
	mm	0.03937	in
Volume / Capacity	cc (cm ³)	0.03527	oz (IMP liq.)
	cc (cm ³)	0.06102	cu-in
	lt (liter)	0.8799	qt (IMP liq.)
	lt (liter)	0.2199	gal (IMP liq.)
Misc.	kg/mm	55.997	lb/in
	kg/cm ²	14.2234	psi (lb/in ²)
	Centigrade (°C)	9/5 + 32	Fahrenheit (°F)

Identification number records.....	9-1
Key identification number	9-1
Vehicle identification number	9-1
Model label.....	9-2

Identification number records

EAU02944

Record the key identification number, vehicle identification number and model label information in the spaces provided for assistance when ordering spare parts from a Yamaha dealer or for reference in case the vehicle is stolen.

1. KEY IDENTIFICATION NUMBER:

2. VEHICLE IDENTIFICATION NUMBER:

3. MODEL LABEL INFORMATION:

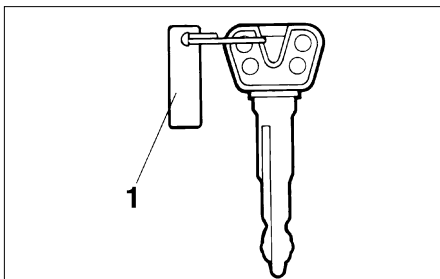

1. Key identification number

EAU01041

Key identification number

The key identification number is stamped on the key tag. Record this number in the space provided and use it for reference when obtaining a new key.

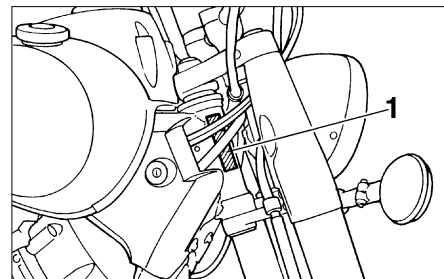

1. Vehicle identification number

EAU01043

Vehicle identification number

The vehicle identification number is stamped into the steering head pipe. Record this number in the space provided.

NOTE: _____

The vehicle identification number is used to identify your motorcycle and may be used to register your motorcycle with the licensing authority in your state.

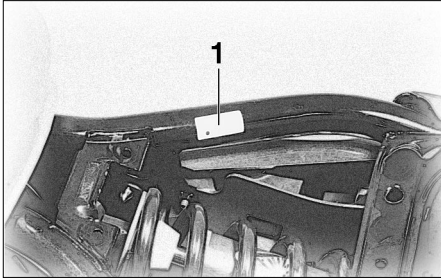

1. Model label

EAU01050

Model label

The model label is affixed to the frame under the seat. (See page 3-9 for seat removal procedures.) Record the information on this label in the space provided. This information will be needed to order spare parts from your Yamaha dealer.

INDEX

A

- Air filter6-12
- Antitheft alarm (optional)3-3

B

- Battery6-26
- Brake and clutch lever lubrication6-24
- Brake and shift pedal lubrication6-23
- Brake fluid replacement6-22
- Brake light switch adjustment6-21

C

- Cable inspection and lubrication6-23
- Carburetor adjustment6-13
- Care7-1
- Checking the front brake pads and rear brake shoes6-21
- Clutch lever3-5
- Clutch lever free play adjustment6-18
- Controls/Instruments (XVS650/XVS650A)2-5

D

- Dimmer switch3-3

E

- Engine break-in5-5
- Engine oil6-9
- Engine stop switch3-4
- Engine trouble indicator light3-2

F

- Final gear oil6-11
- Front brake lever3-5
- Front brake lever free play adjustment6-19
- Front fork inspection6-25
- Front wheel installation6-31
- Front wheel removal6-31
- Fuel3-7
- Fuel cock3-8
- Fuel tank breather hose3-7
- Fuel tank cap3-6
- Fuse replacement6-27

G

- Give safety the right of way1-1

H

- Handlebar switches3-3
 - Dimmer switch3-3
 - Engine stop switch3-4
 - Horn switch3-3
 - Lights switch3-4
 - Pass switch3-3
 - Start switch3-4
 - Turn signal switch3-3
- Headlight bulb replacement6-28
- Helmet holder3-12
- High beam indicator light3-2
- Horn switch3-3

I

- Identification number records9-1
- Idle speed adjustment6-14
- Indicator lights3-2
 - Engine trouble indicator light3-2
 - High beam indicator light3-2
 - Neutral indicator light3-2
 - Turn indicator light3-2
- Inspecting the brake fluid level6-22

K

- Key identification number9-1

L

- Left view (XVS650)2-1
- Left view (XVS650A)2-3
- Lights switch3-4
- Luggage strap holders3-15

M

- Main switch/Steering lock3-1
- Model label9-2

N

- Neutral indicator light3-2

P

- Panel A6-6
- Panel B6-7
- Panel removal and installation6-5
- Parking5-6

Pass switch	3-3
Periodic maintenance and lubrication	6-2
Pre-operation check list	4-1

R

Rear brake pedal	3-6
Rear brake pedal height and free play adjustment	6-20
Rear shock absorber adjustment	3-14
Rear wheel installation	6-33
Rear wheel removal	6-32
Right view (XVS650)	2-2
Right view (XVS650A)	2-4

S

Seats (for XVS650)	3-9
Seats (for XVS650A)	3-11
Shift pedal	3-5
Shifting	5-4
Sidestand	3-15
Sidestand lubrication	6-24
Sidestand/clutch switch operation check	3-16
Spark plugs	6-7
Specifications	8-1
Speedometer	3-2
Start switch	3-4
Starter (choke) “\ ”	3-9
Starting a warm engine	5-4

Starting the engine	5-1
Steering inspection	6-25
Storage	7-4
Storage compartment	3-13
Supporting the motorcycle	6-30

T

Throttle cable and grip lubrication	6-23
Throttle cable free play inspection	6-15
Tips for reducing fuel consumption	5-5
Tires	6-15
Tool kit	6-1
Troubleshooting	6-34
Troubleshooting chart	6-35
Turn indicator light	3-2
Turn signal and taillight bulb replacement	6-29
Turn signal switch	3-3

V

Valve clearance adjustment	6-15
Vehicle identification number	9-1

W

Wheel bearings	6-26
Wheels	6-17



PRINTED ON RECYCLED PAPER

PRINTED IN JAPAN
99 · 5 - 0.6 × 1 CR
(E)